

*SOURCES 4A: A Code for Calculating (α,n),
Spontaneous Fission, and Delayed Neutron
Sources and Spectra*

Los Alamos
NATIONAL LABORATORY

*Los Alamos National Laboratory is operated by the University of California
for the United States Department of Energy under contract W-7405-ENG-36.*

Edited by Maco Stewart, Group CIC-1

An Affirmative Action/Equal Opportunity Employer

This report was prepared as an account of work sponsored by an agency of the United States Government. Neither The Regents of the University of California, the United States Government nor any agency thereof, nor any of their employees, makes any warranty, express or implied, or assumes any legal liability or responsibility for the accuracy, completeness, or usefulness of any information, apparatus, product, or process disclosed, or represents that its use would not infringe privately owned rights. Reference herein to any specific commercial product, process, or service by trade name, trademark, manufacturer, or otherwise, does not necessarily constitute or imply its endorsement, recommendation, or favoring by The Regents of the University of California, the United States Government, or any agency thereof. The views and opinions of authors expressed herein do not necessarily state or reflect those of The Regents of the University of California, the United States Government, or any agency thereof. Los Alamos National Laboratory strongly supports academic freedom and a researcher's right to publish; as an institution, however, the Laboratory does not endorse the viewpoint of a publication or guarantee its technical correctness.

*SOURCES 4A: A Code for Calculating (α,n),
Spontaneous Fission, and Delayed Neutron
Sources and Spectra*

W. B. Wilson

R. T. Perry

W. S. Charlton

*T. A. Parish**

G. P. Estes

T. H. Brown

E. D. Arthur

M. Bozoian

T. R. England

D. G. Madland

J. E. Stewart

**Consultant at Los Alamos. Texas A&M University, College Station, TX 77843*

TABLE OF CONTENTS

Abstract.....	1
I. Introduction	1
II. Theory	4
A. Homogeneous Mixture Problems	4
1. (α,n) Sources.....	4
2. Spontaneous Fission Sources	11
3. Delayed Neutron Sources.....	12
4. Total Neutron Source	12
B. Beam Problems	13
C. Interface Problems	14
D. Three-Region Interface Problems	17
III. File Structure.....	21
IV. Input and Execution	26
A. Homogeneous Problems (<i>idd</i> =1).....	26
B. Interface Problems (<i>idd</i> =2).....	31
C. Beam Problems (<i>idd</i> =3).....	35
D. Three Region Interface Problems (<i>idd</i> =4).....	37
E. Execution.....	42
V. Description of Output	44
VI. Sample Problems	46
A. Homogeneous Mixtures	46
1. Sample Problem #1	46
2. Sample Problem #2	48
3. Sample Problem #3	49
B. Interface Problem Examples	50
1. Sample Problem #4	50
2. Sample Problem #5	52
C. Beam Problem Examples.....	54
1. Sample Problem #6	54

2. Sample Problem #7	56
VII. Acknowledgments.....	58
VIII. References	59
Appendix A - Output Files for Example Problems.....	62
Appendix B - Energy-Dependent, Thick-Target Yields for Various Target Materials	97
Appendix C - General Bibliography	109
Appendix D - Los Alamos Scientific Laboratory Report LA-8869-MS.....	117

SOURCES 4A: A Code for Calculating (α,n), Spontaneous Fission, and Delayed Neutron Sources and Spectra

by

W. B. Wilson, R. T. Perry, W. S. Charlton, T. A. Parish, G. P. Estes, T. H. Brown, E.
D. Arthur, M. Bozoian, T. R. England, D. G. Madland, and J. E. Stewart

ABSTRACT

SOURCES 4A is a computer code that determines neutron production rates and spectra from (α,n) reactions, spontaneous fission, and delayed neutron emission due to the decay of radionuclides. The code is capable of calculating (α,n) source rates and spectra in four types of problems: homogeneous media (i.e., a mixture of α -emitting source material and low-Z target material), two-region interface problems (i.e., a slab of α -emitting source material in contact with a slab of low-Z target material), three-region interface problems (i.e., a thin slab of low-Z target material sandwiched between α -emitting source material and low-Z target material), and (α,n) reactions induced by a monoenergetic beam of α -particles incident on a slab of target material. Spontaneous fission spectra are calculated with evaluated half-life, spontaneous fission branching, and Watt spectrum parameters for 43 actinides. The (α,n) spectra are calculated using an assumed isotropic angular distribution in the center-of-mass system with a library of 89 nuclide decay α -particle spectra, 24 sets of measured and/or evaluated (α,n) cross sections and product nuclide level branching fractions, and functional α -particle stopping cross sections for $Z < 106$. The delayed neutron spectra are taken from an evaluated library of 105 precursors. The code outputs the magnitude and spectra of the resultant neutron source. It also provides an analysis of the contributions to that source by each nuclide in the problem.

I. INTRODUCTION

In many systems, it is imperative to have accurate knowledge of all significant sources of neutrons due to the decay of radionuclides. These sources can include neutrons resulting from the spontaneous fission of actinides, the interaction of actinide decay α -particles in (α,n) reactions with low- or medium-Z nuclides, and/or delayed neutrons from

the fission products of actinides. Numerous systems exist in which these neutron sources could be important. These include, but are not limited to, clean and spent nuclear fuel (UO_2 , ThO_2 , MOX, etc.), enrichment plant operations (UF_6 , PuF_4), waste tank studies, waste products in borosilicate glass or glass-ceramic mixtures, and weapons-grade plutonium (WPU) in storage containers. The SOURCES 4A code was designed to calculate neutron sources (magnitude and spectra) resulting from any of the aforementioned interactions and decays.

The spontaneous fission spectra are calculated with evaluated half-life, spontaneous fission branching, and ν data using Watt spectrum parameters for 43 actinides. The (α, n) spectra are calculated with a library of 89 nuclide decay α -particle spectra, 24 sets of evaluated (α, n) cross sections and product nuclide level branching fractions, and 105 functional α stopping cross sections using an assumed isotropic neutron angular distribution in the center-of-mass system. A maximum α -particle energy of 6.5 MeV is allowed by SOURCES 4A. This restriction is required because of the limitations of the cross section libraries. The delayed neutron sources are calculated from a library of evaluated delayed neutron branching fractions and half-lives for 105 precursors.

The SOURCES 4A code is capable of calculating neutron sources in homogeneous problems (i.e., homogeneous mixtures of α -emitting and low-Z materials), interface problems (i.e., composite material consisting of two separate slab regions), α -beam problems (i.e., a monoenergetic α -beam incident on a low-Z slab), and three-region interface problems (i.e., a thin slab of low-Z target material sandwiched between α -emitting source material and low-Z target material). However, systems that include combinations of these problems must be run separately and then compiled by the user.

SOURCES 4A consists of a FORTRAN 77 (F77) source code, a user-created input file, up to five output files, and four library files. The SOURCES 4A code has been under development for several years with continuing improvements made in methods and data. The original version of SOURCES (SOURCES 1x) was actually named POFEAL and was primarily used for calculating $P_i \text{ OF } E\text{-ALpha}$ [i.e., the probability of an (α, n) interaction with nuclide i by an α -particle prior to stopping in the material].¹ SOURCES 2x was an improvement of the original POFEAL code which included spectra calculations.² Also,

improvements in the calculational algorithm were implemented in this version. The previous addition to the code (SOURCES-3A) was the ability to handle two-region interface problems. Recently the capability to calculate (α, n) source rates and spectra for three-region interface problems was added (SOURCES 4A). SOURCES will continue to be updated and improved as more experimental data and computational methods become available. SOURCES 4A exists for both Unix and PC platforms. The information in this manual is applicable to both the Unix and PC versions; however, installation may vary.

Several works related to SOURCES that are not expressly referenced in the text of this manual are included in Appendix C.

II. THEORY

The SOURCES 4A code is capable of calculating neutron production rates for four different problem configurations (interface, homogeneous, beam, and three-region interface problems) with three different neutron sources: (α ,n), spontaneous fission, and delayed neutrons. In the following section, the theory leading to each of these sources and problems is derived. Also, the methodology used in generating the neutron production functions is described in detail.

A. Homogeneous Mixture Problems

A homogeneous mixture problem is one in which the α -emitting material and spontaneous fission sources are intimately mixed with the low-Z target material (i.e., atoms of α -emitting material are directly adjacent to the target atoms). Three sources of neutrons exist in these problems, namely spontaneous fission neutrons, delayed neutrons, and neutrons emitted as a result of (α ,n) reactions during the slowing down of α -particles. The theory pertaining to calculations for each of these neutron sources is described below. For homogeneous mixture problems, the neutron source (spectra and magnitude) is output as neutrons produced per second per unit volume. It is assumed in all homogeneous mixture calculations that the target is thick (i.e., that the dimensions of the target are much smaller than the range of the α -particles); and thus, all α -particles are stopped within the mixture.

1. (α ,n) Sources

The calculation of the (α ,n) neutron production in a material requires accurate knowledge of the slowing down of the α -particles, as well as the probability of neutron production from an α -particle at energy E_α . The slowing and stopping of α -particles in a material are described by the material's stopping power,

$$SP(E) = -\frac{dE}{dx} \tag{1}$$

which yields the energy loss of α -particles of energy E per unit path length x .³ The energy loss of an α -particle of initial energy E_α in traveling a distance L can be determined from the stopping power as

$$\Delta E = E_\alpha - E'_\alpha = \int_0^L \left(-\frac{dE}{dx} \right) dx. \quad (2)$$

Similarly, the distance traveled in slowing from E_α to E'_α is

$$L = \int_{E'_\alpha}^{E_\alpha} \frac{1}{\left(\frac{dE}{dx} \right)} dE = \int_{E'_\alpha}^{E_\alpha} \frac{1}{\left(-\frac{dE}{dx} \right)} dE. \quad (3)$$

During the slowing down of the α -particles within the material, neutrons may be produced by (α, n) reactions with the nuclides contained in the material. The probability of an (α, n) interaction with nuclide i by an α -particle of energy E traveling from x to $x+dx$ is

$$N_i \sigma_i(E) dx = \frac{N_i \sigma_i(E) dE}{\left(\frac{dE}{dx} \right)} \quad (4)$$

where N_i is the atom density of nuclide i and σ_i is the microscopic (α, n) cross section for nuclide i . The probability of (α, n) interaction with nuclide i by an α -particle that slowed from E_α to E'_α is then

$$p_i(E_\alpha \rightarrow E'_\alpha) = \int_{E'_\alpha}^{E_\alpha} \frac{N_i \sigma_i(E)}{\left(\frac{dE}{dx} \right)} dE = \int_{E'_\alpha}^{E_\alpha} \frac{N_i \sigma_i(E)}{\left(-\frac{dE}{dx} \right)} dE. \quad (5)$$

Thus, the probability of an α -particle undergoing an (α, n) reaction with nuclide i before stopping in the material is given by the thick-target neutron production function,

$$P_i(E_\alpha) = \int_0^{E_\alpha} \frac{N_i \sigma_i(E)}{\left(-\frac{dE}{dx} \right)} dE. \quad (6)$$

The stopping cross section (ϵ) is defined as,

$$\epsilon(E) = -\frac{1}{N} \frac{dE}{dx} \quad (7)$$

where N is the total atom density of the material. The quantities p_i and P_i can now be expressed in terms of the stopping cross section

$$P_i(E_\alpha \rightarrow E'_\alpha) = \frac{N_i}{N} \int_{E'_\alpha}^{E_\alpha} \frac{\sigma_i(E)}{\varepsilon(E)} dE \quad (8)$$

and

$$P_i(E_\alpha) = \frac{N_i}{N} \int_0^{E_\alpha} \frac{\sigma_i(E)}{\varepsilon(E)} dE. \quad (9)$$

In general, any material involved in a homogeneous problem will be composed of any number of different elements (e.g., H, C, and O). The stopping cross section $\varepsilon(E)$ of a material composed of J elemental constituents may be calculated using the Bragg-Kleeman⁴ relationship

$$\varepsilon(E) \cong \frac{1}{N} \sum_{j=1}^J N_j \varepsilon_j(E) \quad (10)$$

where

$$N = \sum_{j=1}^J N_j. \quad (11)$$

A fraction of the decays of nuclide k within a material may be via α -particle emission. This fraction (F_k^α) of alpha decays may occur with the emission of one of L possible α -particle energies. The intensity f_{ki}^α is the fraction of all decays of nuclide k resulting in an α -particle of energy E_i ; and thus,

$$F_k^\alpha = \sum_{i=1}^L f_{ki}^\alpha. \quad (12)$$

Therefore, the fraction of nuclide k decays resulting in an (α, n) reaction in a thick-target material containing I nuclides with non-negligible (α, n) cross sections is

$$R_k(\alpha, n) = \sum_{i=1}^L f_{ki}^\alpha \sum_{i=1}^I P_i(E_i). \quad (13)$$

The value for $P_i(E_i)$ will be determined using the discrete form of Eq. (9),

$$P_i(E_i) = \frac{N_i}{N} \sum_{g=1}^{G-1} \frac{1}{2} \left[\frac{\sigma_i^{g+1}}{\varepsilon^{g+1}} + \frac{\sigma_i^g}{\varepsilon^g} \right] (E^{g+1} - E^g) \quad (14)$$

where $\sigma_i^1 = \sigma_i(0)$, $\sigma_i^G = \sigma_i(E_i)$, $\varepsilon^1 = \varepsilon(0)$, and $\varepsilon^G = \varepsilon(E_i)$ (i.e., the energy range has been discretized into G-1 energy groups). It is important to note that to calculate the (α, n)

neutron source per decay of nuclide k , it is necessary to have accurate knowledge of the discrete-energy (α,n) cross section for each target nuclide (σ^g), discrete energy stopping cross section (ϵ^g) for all elemental constituents, atom fraction (N_i/N) for each target nuclide, the intensity for emission of each of L α -particles (f_{ki}^α), and the energy of each of the L α -particles (E_i). The atom fractions are provided by the user in a file named *tape1*. The other quantities are available to SOURCES from a number of library files (see Section III).

The (α,n) spectra are determined assuming an isotropic neutron angular distribution in the center-of-mass (COM) system⁵ with a library of 89 nuclide decay α spectra and 24 sets of product-nuclide level branching fractions. Figure 1 shows an illustration of a general (α,n) reaction in the laboratory system where any associated gamma ray is assumed to be emitted after the neutron is emitted. This assumption is identical to neglecting the momentum of any associated gamma ray, but it accounts for its energy.

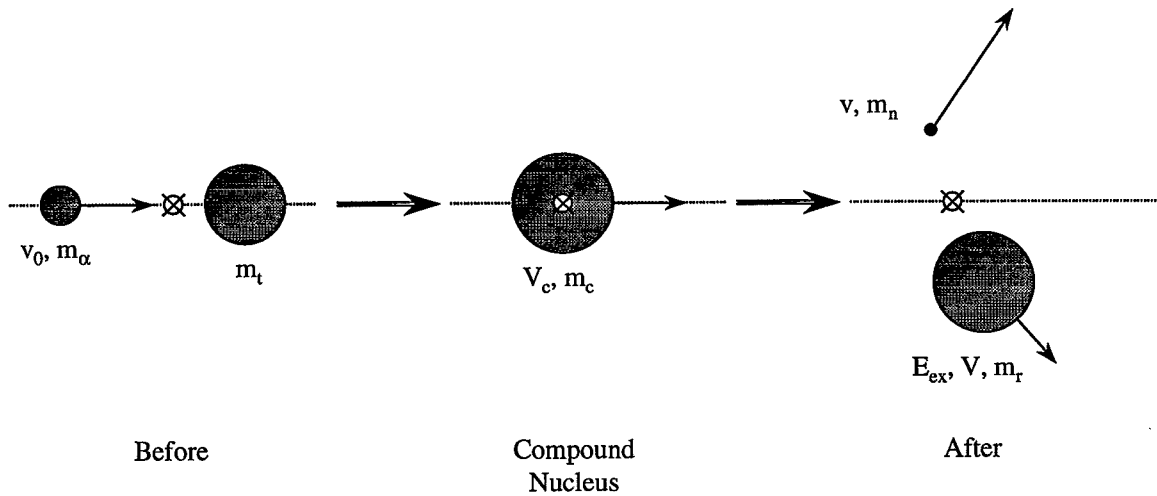

Fig. 1. (α,n) Reaction in the Laboratory System.

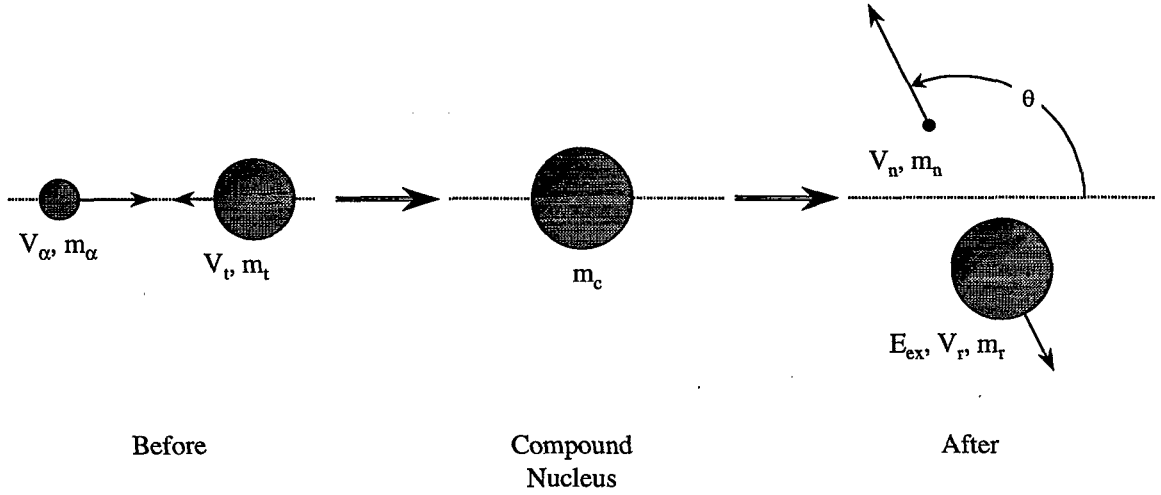

Fig. 2. (α, n) Reaction in the Center-of-Mass System.

It is readily apparent from conservation of momentum that the velocity of the center-of-mass (V_c) is simply given by

$$V_c = \left(\frac{m_\alpha}{m_\alpha + m_t} \right) v_0. \quad (15)$$

This is also equivalent to the velocity of the compound nucleus, assuming the compound nucleus is not in an excited state. Subtracting the velocity of the COM from the particle velocities displayed in Fig. 1 allows for a transformation to the COM coordinate system (Fig. 2). The α -particle velocity in the COM system is given by

$$V_\alpha = v_0 \left(\frac{m_t}{m_\alpha + m_t} \right). \quad (16)$$

The target nuclide velocity in the COM system is

$$V_t = -v_0 \left(\frac{m_\alpha}{m_\alpha + m_t} \right). \quad (17)$$

From conservation of energy in the COM system, we find

$$KE_n = (Q - E_{ex}) + KE_\alpha + KE_t - KE_r, \quad (18)$$

where KE_n is the neutron kinetic energy, KE_α is the α -particle kinetic energy, KE_t is the target nucleus kinetic energy, KE_r is the recoil nucleus kinetic energy, E_{ex} is the excitation level of the recoil nucleus, and Q is the reaction Q -value (all variables in the COM

system). It is customary to define the reaction Q-value for production of product-nuclide level m as

$$Q_m = Q - E_{ex}. \quad (19)$$

From conservation of momentum in the vertical direction we see

$$V_r = \left(\frac{m_n}{m_r} \right) V_n. \quad (20)$$

Using Eq.'s (16) and (17), it can be shown that

$$KE_\alpha + KE_t = E_\alpha \left(\frac{m_t}{m_\alpha + m_t} \right) \quad (21)$$

where E_α is the α -particle kinetic energy in the laboratory system. The recoil nuclei kinetic energy is given by

$$KE_r = \frac{1}{2} m_r V_r^2 = \frac{1}{2} \frac{m_n^2}{m_r} V_n^2 = KE_n \left(\frac{m_n}{m_r} \right) \quad (22)$$

where we have made use of Eq. (20) and the definition of the neutron kinetic energy.

Substituting Eq.'s (19), (21), and (22) into Eq. (18) yields

$$KE_n = Q_m + E_\alpha \left(\frac{m_t}{m_\alpha + m_t} \right) - KE_n \left(\frac{m_n}{m_r} \right). \quad (23)$$

Solving Eq. (23) for the neutron kinetic energy yields

$$KE_n = Q_m \left(\frac{m_r}{m_r + m_n} \right) + E_\alpha \left(\frac{m_t}{m_\alpha + m_t} \right) \left(\frac{m_r}{m_r + m_n} \right). \quad (24)$$

Using the definition of kinetic energy, the neutron velocity in COM system can be acquired as

$$V_n = \pm \sqrt{\frac{Q_m}{m_n} \frac{2m_r}{m_r + m_n} + \frac{2E_\alpha}{m_n} \frac{m_t}{m_t + m_\alpha} \frac{m_r}{m_r + m_n}}. \quad (25)$$

This can be converted to the neutron velocity in the laboratory system by adding the velocity of the COM

$$v = \sqrt{\frac{2E_\alpha}{m_\alpha} \left(\frac{m_\alpha}{m_\alpha + m_t} \right)} \pm \sqrt{\frac{Q_m}{m_n} \frac{2m_r}{m_r + m_n} + \frac{2E_\alpha}{m_n} \frac{m_t}{m_t + m_\alpha} \frac{m_r}{m_r + m_n}}. \quad (26)$$

Eq. (26) can be expressed easily in terms of the square root of the neutron kinetic energy as

$$\sqrt{E_{n,m}} = \pm \sqrt{\frac{1}{2} m_n v} \quad (27)$$

where $E_{n,m}$ is the neutron kinetic energy in the laboratory frame of reference from an incident α -particle of energy E_α and generating a product nuclei of level m . Thus the neutron kinetic energy is

$$E_{n,m}^\pm = \left(\sqrt{E_\alpha a_1} \left(\frac{1}{1+a_2} \right) \pm \sqrt{Q_m \frac{1}{1+a_3} + E_\alpha \frac{a_2}{1+a_2} \frac{1}{1+a_3}} \right)^2 \quad (28)$$

where we have defined

$$a_1 = \frac{m_n}{m_\alpha} \quad (29)$$

$$a_2 = \frac{m_t}{m_\alpha} \quad (30)$$

and

$$a_3 = \frac{m_n}{m_r} \quad (31)$$

Equation (28) relates the maximum (+ second term) and minimum (– second term) permissible neutron kinetic energies from an incident α -particle of energy E_α generating a product nuclide with level m .

For each target nuclide and each source α -particle, the code can read the number of product-nuclide levels (M_i), the number of product level branching data points (M'_i), the (α,n) reaction Q-value (Q^i), the excitation energy of each product-nuclide level [$E_{ex}^i(m)$], and the fraction of (α,n) reactions at energy $E(m)$ resulting in the production of product level m [$f_i(m,m')$] from the library files. The neutron energy spectra will be discretized into a user-defined energy group structure. The fraction of target i product level m reactions of source k α -particles occurring in α -particle energy group g is

$$H_{i,k}^l(m) = \frac{P_i(E_{l+1}) - P_i(E_l)}{P_i(E_\alpha)}, \quad (32)$$

where $P_i(E_i)$ was defined in Eq. (14). The branching fraction of α -particles at E_α reacting with target nuclide i and producing product level m is

$$S_{i,k}(m) = f_i(m, m^2-1) + (f_i(m, m^2) - f_i(m, m^2-1)) \frac{E_\alpha - E(m^2-1)}{E(m^2) - E(m^2-1)}. \quad (33)$$

Thus, the fraction of α -particles at E_α reacting with target nuclide i and resulting in product level m reactions occurring in α -particle energy group g is simply the product of Eq.'s (32) and (33):

$$F_{i,k}^l(m) = S_{i,k}(m) H_{i,k}^l(m). \quad (34)$$

It will be assumed that the neutrons are isotropically emitted from the compound nucleus; therefore, they will contribute evenly to all groups between $E_{n,m}^+$ and $E_{n,m}^-$. The contribution per decay of source nuclide k to neutron energy group g is given by

$$\chi_k^{(\alpha,n)}(E_g) = R_k(\alpha, n) F_{i,k}^l(m) \frac{E_{g+1} - E_g}{E_{n,m}^+ - E_{n,m}^-}, \quad (35)$$

where E_{g+1} and E_g are between $E_{n,m}^+$ and $E_{n,m}^-$.

2. Spontaneous Fission Sources

The spontaneous fission of an actinide nuclide k is accompanied by the emission of an average $\nu_k(SF)$ neutrons. The fraction of nuclide k decays that are spontaneous fission events are given by the SF branching fraction

$$F_k^{SF} = \frac{\lambda_k^{SF}}{\lambda_k}. \quad (36)$$

Thus, the average number of SF neutrons emitted per decay of nuclide k (by any mode) is

$$R_k(SF) = F_k^{SF} \nu_k(SF). \quad (37)$$

Therefore, to compute the neutron production due to spontaneous fission per decay of nuclide k , the SF branching fraction and average number of neutrons per spontaneous fission must be known. These quantities are available to SOURCES from a library file named *tape5* (see Section III).

The spontaneous fission neutron spectra are approximated by a Watt's fission spectra using two evaluated parameters (a and b):

$$\chi_k^{SF}(E) = R_k(SF) e^{-E/a} \sinh \sqrt{bE}. \quad (38)$$

Evaluated parameters are provided for 43 fissioning nuclides in the *tape5* library file (see Section III below).

3. Delayed Neutron Sources

During the fissioning process, a number of products are formed including neutrons, gamma rays, beta rays, neutrinos, fission products, and an appreciable amount of energy. Some of the fission products formed as a result of fission can decay by β^- emission to a highly excited state, which can then decay by emitting a neutron. These neutrons are called "delayed neutrons" because they appear within the system with some appreciable time delay. The nuclide emitting the neutron is referred to as the "delayed neutron emitter," and the nuclide which β^- decays to the emitter is referred to as a "delayed neutron precursor." It is customary to assume that one neutron is emitted per decay and that the emitter decays almost instantaneously. Thus, the fraction of decays by nuclide k (by any mode) leading to the emission of a delayed neutron is given by the product of the DN branching fraction (F_k^{DN}):

$$R_k(DN) = F_k^{DN}. \quad (39)$$

Computing the neutron production rate due to delayed neutron emission requires knowledge of the DN branching fraction. The value for F_k^{DN} is provided to SOURCES in a library file (see Section III).

A series of evaluated delayed neutron spectra are provided in a library file for 105 precursor nuclides [$\phi_k(E)$]. These evaluated spectra are provided in a discretized form. They are read directly into SOURCES and then adjusted so that the default spectra energy mesh correlates with the user-desired energy mesh. The energy spectra is then renormalized by multiplying through by the quantity $R_k(DN)$, such that

$$\chi_k^{DN}(E) = R_k(DN)\phi_k(E). \quad (40)$$

4. Total Neutron Source

The average total number of neutrons per decay emitted due to (α, n) reactions, spontaneous fission, and delayed neutron emission is given by

$$R_k = R_k(\alpha, n) + R_k(SF) + R_k(DN). \quad (41)$$

Therefore, the total neutron source from (α,n) reactions, spontaneous fission, and delayed neutron emission within a homogenous problem consisting of K pertinent radionuclides is

$$S = \sum_{k=1}^K \lambda_k N_k R_k \quad (42)$$

where λ_k is the decay constant for nuclide k and N_k is the atom density of nuclide k . A similar expression will be used for the source produced in interface and beam problems.

The energy-dependent neutron source spectra are calculated using the absolute (α,n), SF, and DN spectra calculated above for each nuclide k by an expression similar to that given in Eq. (42):

$$S_g = \lambda_k N_k \chi_k(E_g) \quad (43)$$

where

$$\chi_k(E_g) = \chi_k^{(\alpha,n)}(E_g) + \chi_k^{SF}(E_g) + \chi_k^{DN}(E_g). \quad (44)$$

B. Beam Problems

A beam problem is one in which a monoenergetic α -beam is incident upon a slab containing low- Z target material (see Fig. 3). The slab could also contain higher mass isotopes; however, actinides (i.e., α -emitting or spontaneous fissioning material) will not be used to calculate a source. It is a necessary condition that the thickness of the slab of target material (t) be significantly larger than the range of the α -particles in the beam (i.e., that all α -particles come to rest within the target slab).

The neutron production rate within the slab per incident α -particle is a function of the α -particle beam energy (E_α) and the probability of an (α,n) interaction with any nuclide i within the slab by an α -particle from the beam prior to stopping in the material,

$$S = \sum_{i=1}^I P_i(E_\alpha). \quad (45)$$

The beam energy (E_α) must be supplied by the user. The thick-target neutron production function [$P_i(E_\alpha)$] is calculated using Eq. (14) above. The neutron spectra are calculated using the same procedure as described in Section II.A.1.

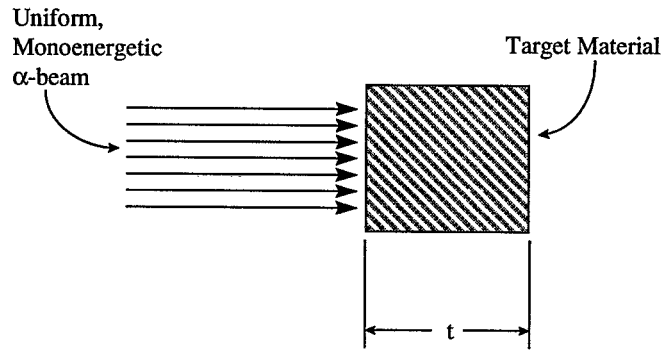

Fig. 3. General Schematic for Beam Problems.

C. Interface Problems

Interface problems (Fig. 4) exist when a slab of α -emitting material (such as Pu, Po, or Am) is in close contact with a low-Z target material (such as Be, C, or Al). In these problems, α -particles are emitted from the Region I materials and travel across the interface junction into the Region II materials. In Region II, the α -particles can interact through (α, n) reactions and generate a neutron source. It is necessary to assume that in all interface problems the thickness of each region is significantly larger than the range of the α -particles within it. Also, it will be assumed that all α -particles travel in a straight-line trajectory from their point of emission (generally an excellent assumption).

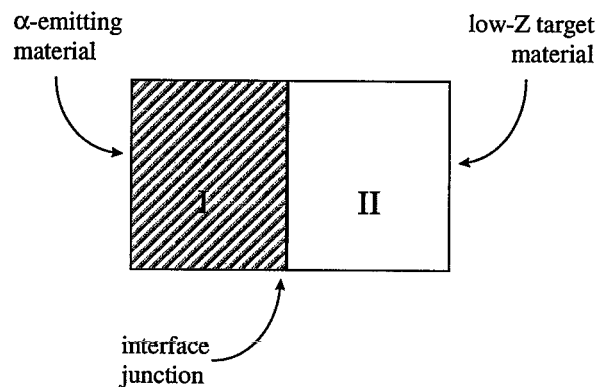

Fig. 4. General Schematic for Interface Problems.

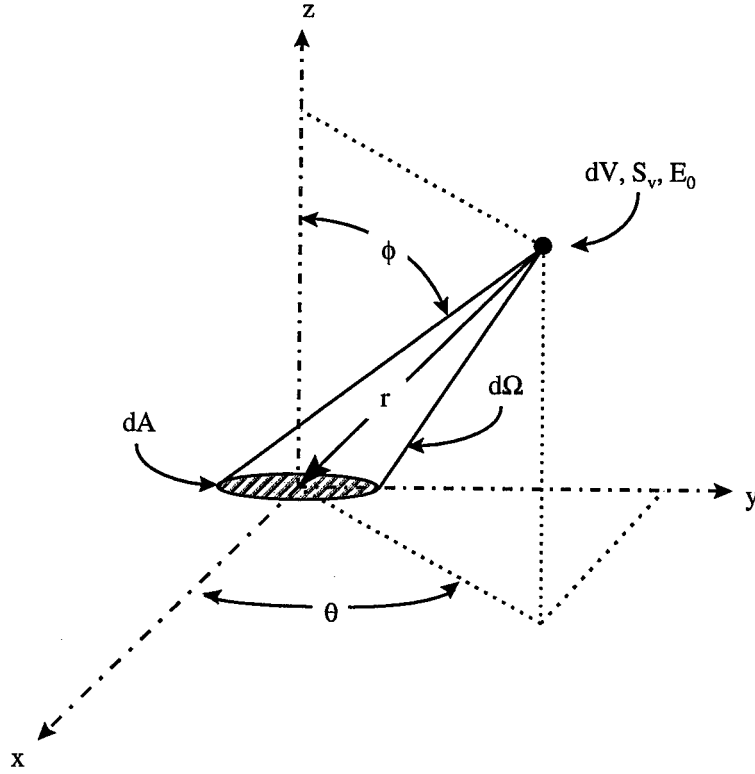

Fig. 5. The α -Particle Solid Angle to Differential Area Due to Generalized α Source.

To derive the α -particle source rate at the interface, consider the half-space above the x-y plane shown in Fig. 5. There exists a uniform volumetric source (S_v) of α -particles in this half-space. The α -particles are assumed to be emitted isotropically with initial energy E_0 . The differential area dA subtends a solid angle $d\Omega$ when viewed from the source point dV . Thus,

$$d\Omega = \frac{\cos \phi}{r^2} dA \quad (46)$$

and

$$dV = r^2 \sin \phi \cdot d\theta \cdot d\phi \cdot dr. \quad (47)$$

The rate at which α -particles are born in dV is equal to

$$S_v dV = S_v r^2 \sin \phi \cdot d\theta \cdot d\phi \cdot dr. \quad (48)$$

The solid angle subtended by dA relative to the total solid angle into which α -particles are emitted is given by

$$\frac{d\Omega}{4\pi} = \frac{\cos \phi \cdot dA}{4\pi \cdot r^2}. \quad (49)$$

Multiplying Eq. (48) by Eq. (49) yields the number of α -particles per unit time originating within dV that can pass through dA provided that r is less than the α -particle range, or

$$dU = \frac{S_v}{4\pi} \sin \phi \cos \phi \cdot dA \cdot d\theta \cdot d\phi \cdot dr. \quad (50)$$

The rate at which α -particles pass through dA as a result of having been born in a hemispherical shell centered about dA whose radius is r and thickness is dr is acquired by integrating Eq. (50) over θ and ϕ , or

$$dU' = \frac{S_v}{4\pi} dA \cdot dr \int_0^{2\pi} d\theta \int_0^{\pi/2} \sin \phi \cos \phi \cdot d\phi. \quad (51)$$

Performing the integration yields

$$dU' = \frac{S_v}{4} dA \cdot dr. \quad (52)$$

From Eq. (7) we see

$$dr = -\frac{1}{N} \frac{dE}{\epsilon(E)} \quad (53)$$

where $\epsilon(E)$ is the stopping cross section and N is the total atom density of the material in the region. Thus, the rate at which α -particles pass through the interface per unit area is given by

$$\frac{dU'}{dA} = -\frac{S_v}{4N} \frac{1}{\epsilon(E)} dE. \quad (54)$$

Therefore, the rate at which α -particles with energies between E_g and E_{g+1} pass through the interface per unit area (Φ) is

$$\Phi^g = \frac{U}{A} = \frac{S_v}{4N} \int_{E_g}^{E_{g+1}} \frac{dE}{\epsilon(E)}. \quad (55)$$

The volumetric source (S_v) can be expressed as

$$S_v = \lambda_k N_k f_{kl}^\alpha \quad (56)$$

where λ_k is the decay constant for source nuclide k , N_k is the atom density of source nuclide k , and f_{kl}^α is the fraction of all decays of nuclide k resulting in an α -particle of energy E_{kl} . Thus we see that

$$\Phi^g = \frac{\lambda_k f_{kl}^\alpha N_k}{4 N} \int_{E_g}^{E_{g+1}} \frac{dE}{\varepsilon(E)}. \quad (57)$$

This quantity (Φ^g) is the source of α -particles between energies E_g and E_{g+1} passing into the low- Z target material (Region II) per unit area and per unit time. The quantity Φ^g is then used by SOURCES as the source strength of a monoenergetic beam with energy:

$$E_{beam}^g = \frac{E_g + E_{g+1}}{2}. \quad (58)$$

SOURCES can then use the same procedure developed in Section II.B to solve for the neutron production rate due to the α -particles crossing the junction with energies between E_g and E_{g+1} . SOURCES then repeats this procedure for all α -particle energies and all source nuclides.

D. Three-Region Interface Problems

A three-region (α,n) problem consists of an α -emitting slab (such as Pu, Po, or Am) in direct contact with a thin slab of low- Z target material (such as Be, C, or Al) which is itself in contact with a thick (α,n) target (Fig. 6). In this particular problem, α -particles born in region A, can slow through region A to interface ab , slow through region B to interface bc , and slow to a stop in region C. Thus, neutrons can be produced in both region B and region C due to the slowing α -particles.

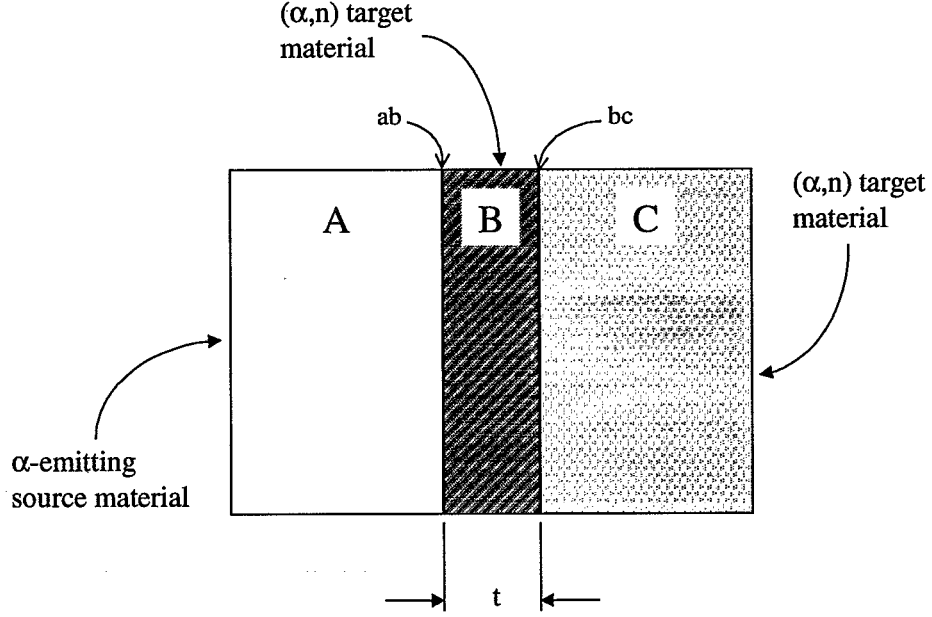

Fig. 6. General Schematic for Three-Region Interface Problem.

This problem is significantly more complicated than the two-region variety due to the dependence on the thickness of the track through region B and thus an inherent angular dependence. It is necessary to assume that in all interface problems the thickness of regions A and C is significantly larger than the range of the α -particles within it. Region B can have any thickness. It will also be assumed that all α -particles travel in a straight-line trajectory from their point of emission (generally an excellent assumption).

The number of α -particles crossing interface ab with energies between E_g and E_{g+1} is given by:

$$\Phi_{ab}^g = \sum_{k=1}^{NN} \sum_{l=1}^{NL_k} \frac{\lambda_k f_{kl}^\alpha}{4} \left(\frac{N_k}{N} \right)_A m_{kl}^g \left(\frac{1}{\epsilon_A^g} + \frac{1}{\epsilon_A^{g+1}} \right) \left(\frac{E_{g+1} - E_g}{2} \right) \quad (59)$$

where λ_k is the decay constant of α -emitting source nuclide k, f_{kl}^α is the fraction of all nuclide k decays that result in the production of an α -particle at energy E_l , $(N_k/N)_A$ is the atom fraction of α -emitting source nuclide k in region A, ϵ_A^g is the stopping cross section of region A at energy E_g , and m_{kl}^g is a calculational factor given by:

$$m_{kl}^g = \begin{cases} 0 & \text{if } E_g > E_{kl}^\alpha \\ 1 & \text{if } E_{g+1} < E_{kl}^\alpha \\ \frac{E_{kl}^\alpha - E_g}{E_{g+1} - E_g} & \text{if } E_g < E_{kl}^\alpha < E_{g+1} \end{cases} \quad (60)$$

The only assumption made in equation (59) is that the function $1/\epsilon_A^g$ is linear between E_g and E_{g+1} .

To calculate the α -particle source rate at the interface bc, we first must determine the energies at which the α -particles transition from region A to region B at an angle between ϕ_i and ϕ_{i+1} and end up at interface bc with energies between E_g and E_{g+1} . We will calculate these energies by performing the following:

$$\min_{i,trans_{i,g}} \left[\sum \left(\frac{1}{\epsilon_B^{g'}} + \frac{1}{\epsilon_B^{g'+1}} \right) \left(\frac{E_{g'+1} - E_{g'}}{2} \right) > \frac{t}{\cos(\phi_i)} \right] \quad \text{for all } i \text{ and } g \quad (61)$$

where $i,trans_{i,g}$ is the transition energy index and t is the thickness of the intermediate region B. The number of α -particles crossing interface bc with energies between E_g and E_{g+1} is given by:

$$\Phi_{bc}^g = \sum_{k=1}^{NN} \sum_{l=1}^{NL_k} \sum_{i=1}^I P_{g,i,k,l} \frac{\lambda_k f_{kl}^\alpha}{8} \left(\frac{N_k}{N} \right)_A (\cos(2\phi_i) - \cos(2\phi_{i+1})) m_{kl}^g \left(\frac{1}{\epsilon_A^g} + \frac{1}{\epsilon_A^{g+1}} \right) \left(\frac{E_{g+1} - E_g}{2} \right) \quad (62)$$

where λ_k is the decay constant of α -emitting source nuclide k , f_{kl}^α is the fraction of all nuclide k decays that result in the production of an α -particle at energy E_{kl}^α , $(N_k/N)_A$ is the atom fraction of α -emitting source nuclide k in region A, ϵ_A^g is the stopping cross section of region A at energy E_g , m_{kl}^g is a calculational factor given in equation (2) above, and $P_{g,i,k,l}$ is a calculational factor given by:

$$P_{g,i,k,l} = \begin{cases} 0 & \text{if } E_{i,trans_{i,g}} > E_{kl}^\alpha \\ 1 & \text{if } E_{i,trans_{i,g}} < E_{kl}^\alpha \end{cases} \quad (63)$$

These α -particle source rates can now be used to calculate the neutron production rates in a manner not dissimilar to what was used in section II.C. above. To accomplish this we will calculate the neutron production rates and spectra from the α -particle source at interface ab due to material B assuming region B is infinitely thick ($\Psi_{ab,B}^g$). We will then

calculate the neutron production rates and spectra from the α -particle source at interface bc due to material B assuming region C is infinitely thick ($\Psi_{bc,B}^g$). Then, we will calculate the neutron production rates and spectra from the α -particle source at interface bc due to material C assuming region C is infinitely thick ($\Psi_{bc,C}^g$). The total neutron production rates and spectra due to the interface is then given by:

$$\Psi^g = \Psi_{bc,C}^g + \left(\Psi_{ab,B}^g - \Psi_{bc,B}^g \right). \quad (64)$$

These multigroup neutron source rates are then output to a file for the user.

III. FILE STRUCTURE

The SOURCES 4A code system is composed of an F77 source code, an executable, an input file, several output files, and a series of library files. All of these files (except for the output files which SOURCES will generate) are necessary for proper execution of the SOURCES code. The name and a short description of each file included in the SOURCES 4A code system are included below:

- tape1 = user input file*
- tape2 = stopping cross section expansion coefficients library*
- tape3 = target (α,n) cross section library*
- tape4 = target (α,n) product level branching library*
- tape5 = sources decay data library*
- tape6 = neutron source magnitudes output file*
- tape7 = absolute neutron spectra output file*
- tape8 = normalized neutron spectra output file*
- tape9 = neutrons spectra output file by product level*
- outp = summary output file*
- SOURCE4A.for = F77 source code*
- SOURCE4A.exe = executable code.*

Fig. 7 illustrates the sources code structure and how each file interacts with the executable file.

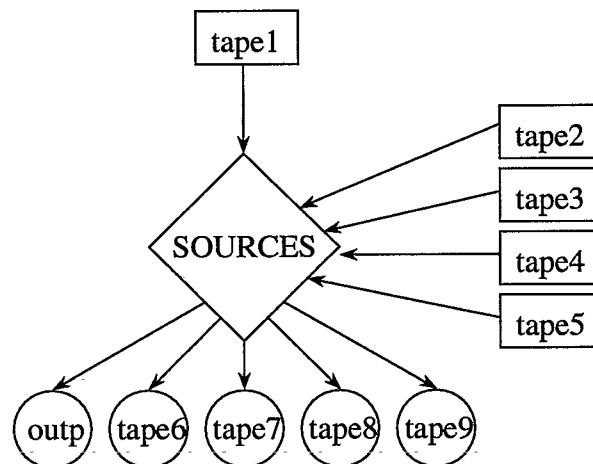

Fig. 7. Schematic Diagram of the SOURCES 4A File Structure.

The data necessary for computing the magnitude of the neutron source due to (α,n) reactions, spontaneous fission, and delayed neutron emission are:

1. The energy-dependent α -particle stopping cross section for all elemental constituents (ϵ_i^e).
2. The energy dependent (α,n) cross section for all target nuclides (σ_i^e).
3. The intensity for emission of each of the L α -particles (f_{kl}^α).
4. The energy of each of the L α -particles (E_l).
5. The SF branching fractions for each source nuclide k (F_k^{SF}).
6. The average number of neutrons per SF of nuclide k [$\nu_k(SF)$].
7. The DN branching fraction for each nuclide k (F_k^{DN}).
8. The source nuclide decay constants (λ_k).

To calculate the neutron source spectrum, it is necessary to have data for:

1. The number of product nuclide levels (M) for all target nuclides.
2. The number of product nuclide level branching data points (M') for all target nuclides.
3. The (α,n) reaction Q-value for all target nuclides.
4. The excitation energy [$E_{ex}(m)$] of product nuclide level m for all target nuclides.
5. The fraction of (α,n) reactions with target i at energy E(m) resulting in the production of product level m.
6. The α -particle, neutron, target, and product nuclei masses.
7. Watt's fission spectrum parameters (a and b) for each source nuclide k.
8. Delayed neutron energy spectrum for each source nuclide k.

All of these parameters are included in the library files. The library files contain (α,n) target nuclide cross section parameters for all the nuclei listed in Table I and source parameters for all the nuclei listed in Table II. These nuclides are listed in ZAID format and are defined as ZAID = state + (10A) + (10000Z), where Z is the atomic number, A is the atomic mass, and the state is either 0 or 1 for ground or metastable, respectively.

TABLE I
 (α, n) Target Isotopes Available in SOURCES 4A.

Isotope	ZAID	Level Branching Fraction Data Source	Cross Section Data Source
Li-7	030070	GNASH	Gibbons and Macklin ⁶
Be-9	040090	Geiger and Van der Zwan ⁷	Geiger and Van der Zwan ⁷
B-10	050100	GNASH	Bair <i>et al.</i> ⁸
B-11	050110	GNASH	Bair <i>et al.</i> ⁸
C-13	060130	GNASH ^a	Bair and Haas ⁹
N-14	070140	N/A ^b	GNASH
O-17	080170	Lesser and Schenter ¹⁰	Perry and Wilson ¹
O-18	080180	Lesser and Schenter ¹⁰	Perry and Wilson ¹
F-19	090190	Lesser and Schenter ¹⁰	Balakrishnan <i>et al.</i> ¹¹
Ne-21	100210	N/A ^b	GNASH
Ne-22	100220	N/A ^b	GNASH
Na-23	110230	GNASH	GNASH ^a
Mg-25	120250	GNASH	GNASH
Mg-26	120260	GNASH	GNASH
Al-27	130270	GNASH	GNASH ^a
Si-29	140290	GNASH	GNASH ^a
Si-30	140300	GNASH	GNASH ^a
P-31	150310	GNASH	GNASH
Cl-37	170370	GNASH	Woosley <i>et al.</i> ¹²

^a GNASH calculated and measured data (in that order) are available for these nuclides in the library file. By default, the GNASH calculation is used (actually SOURCES uses the first data set that it encounters during the reading of the file). To use an alternate data set, the library file must be altered by reversing the order in which these data sets occur in the file.

^b Nuclide level branching data for these isotopes are absent from the library files. Thus, problems containing these isotopes can be executed only for neutron source magnitudes ($id=1$) and not for neutron source spectra ($id=2$).

TABLE II
Actinide Isotopes Available as Decay Sources in SOURCES 4A.

Isotope	ZAID
Ce-142	581420
Nd-144	601440
Sm-146	621460
Sm-147	621470
Sm-148	621480
Sm-149	621490
Gd-152	641520
Pb-210	822100
Bi-210	832100
Bi-211	832110
Bi-212	832120
Bi-213	832130
Bi-214	832140
Po-210	842100
Po-211	842110
Po-212	842120
Po-213	842130
Po-214	842140
Po-215	842150
Po-216	842160
Po-218	842180
At-215	852150
At-217	852170
At-218	852180
At-219	852190
Rn-217	862170
Rn-218	862180
Rn-219	862190
Rn-220	862200
Rn-222	862220
Fr-221	872210
Fr-222	872220
Fr-223	872230
Ra-222	882220
Ra-223	882230

Isotope	ZAID
Ra-224	882240
Ra-226	882260
Ac-225	892250
Ac-226	892260
Ac-227	892270
Th-226	902260
Th-227	902270
Th-228	902280
Th-229	902290
Th-230	902300
Th-232	902320
Pa-230	912300
Pa-231	912310
U-230	922300
U-232	922320
U-233	922330
U-234	922340
U-235	922350
U-236	922360
U-237	922370
U-238	922380
U-239	922390
Np-236	932360
Np-237	932370
Np-238	932380
Np-239	932390
Pu-235	942350
Pu-236	942360
Pu-237	942370
Pu-238	942380
Pu-239	942390
Pu-240	942400
Pu-241	942410
Pu-242	942420
Pu-243	942430

Isotope	ZAID
Pu-244	942440
Am-240	952400
Am-241	952410
Am-242	952420
Am-242m	952421
Am-243	952430
Am-244	952440
Am-244m	952441
Cm-240	962400
Cm-241	962410
Cm-242	962420
Cm-243	962430
Cm-244	962440
Cm-245	962450
Cm-246	962460
Cm-247	962470
Cm-248	962480
Cm-250	962500
Bk-249	972490
Cf-248	982480
Cf-249	982490
Cf-250	982500
Cf-251	982510
Cf-252	982520
Cf-253	982530
Cf-254	982540
Es-253	992530
Es-254	992540
Es-254m	992541
Es-255	992550
Fm-254	1002540
Fm-255	1002550
Fm-256	1002560
Fm-257	1002570

Stopping-power coefficients (which are a function of atomic number only) are included for all elemental constituents with $Z \leq 105$. The data by Ziegler *et al.*¹³ was used for all $Z \leq 92$. The stopping power coefficients calculated by Perry and Wilson² were used for $92 < Z \leq 105$.

IV. INPUT AND EXECUTION

The SOURCES input is designed to be relatively simple; however, its length can vary over a wide range from exceptionally short (≤ 10 lines) to very long (≥ 50 lines). This large range depends on the number of nuclides (source and target) contained in the problem. Appropriate knowledge of the physics (both macroscopic and microscopic) present in a problem is vital for proper execution of SOURCES (see the Po-Be sample problems in Section VI). All SOURCES input is free format with spaces as delimiters (or commas; however, spaces look better). The input deck should be created in a file named *tape1* for use by the SOURCES executable. Every SOURCES problem begins with the same two cards:

card 1: title

card 2: idd id

The first card is a title card with a maximum length of 77 characters. The second card contains two records (*idd* and *id*), which define the type of problem to be considered (homogeneous, interface, or beam) and the type of neutron source output to be produced (magnitudes only or magnitudes and spectra), respectively. The record *idd* can be either a 1 (for a homogeneous problem), a 2 (for an interface problem), or a 3 (for a beam problem). The record *id* can be either a 1 (for magnitudes only) or a 2 (for magnitudes and spectra). The remaining input cards depend upon the type of problem being considered.

A. Homogeneous Problems (*idd=1*)

A homogeneous problem must contain at least 8 cards which describe the elemental constituents in the material, the neutron energy group structure to be used in the output, the source nuclides present, the type of stopping cross sections to be used, and the (α, n) target nuclides present. If multiple materials are present or neutron energy spectra are requested, then more cards can exist in the input deck.

Cards 1-9 for a homogeneous problem are as follows:

card 1: title

card 2: idd id

card 3: *nz isg*
card 4.1 - 4.nz: *jzm(j) azm(j)*
card 5: *nng enmax enmin* (if necessary)
card 5.1 - 5.nng: *en(n)* (if necessary)
card 6: *nq*
card 7.1 - 7.nq: *jq(k) aq(k)*
card 8: *nt nag*
card 9.1 - 9.nt: *idt(i) at(i)*

Multiple cards are designated by subcards (i.e., if $nz=3$, then the input deck would include card 3 and subcards 4.1, 4.2, and 4.3). Each card must be entered on a new line (the exceptions are subcards 5.1 through 5.nng where all records $en(n)$ can be entered on the same line or multiple lines). Several example input decks are included below to illustrate the procedure described above. Each record is defined as follows:

$nz =$ the number of stopping cross section elemental constituents present in the material (must be an integer between 0 and 20).
 $isg =$ the type of stopping cross sections to be used (0 for solid stopping cross sections, 1 for gas stopping cross sections).
 $jzm(j) =$ the atomic number of each stopping cross section elemental constituent from $j=1$ to nz .
 $azm(j) =$ the fraction of all atoms that are element j .
 $nng =$ the number of neutron spectrum energy groups (integer between 1 and 750 or between -1 and -750); read only if $id=2$, otherwise omitted. If nng is positive, then the energy group structure will be determined by a linear interpolation between $enmax$ and $enmin$ (cards 5.1 through 5.nng are omitted). If nng is negative, then the energy group upper bounds must be specified on cards 5.1 through 5.nng (however, $enmax$ and $enmin$ must still be included).
 $enmax =$ the maximum neutron energy in MeV (read only if $id=2$, otherwise omitted).

- enmin* = the minimum neutron energy in MeV (read only if *id*=2, otherwise omitted).
- en(n)* = the upper energy bound in MeV of neutron groups, listed in descending order (must contain *nng* records in any format); read only if *id*=2 and *nng* is negative (otherwise omitted).
- nq* = the number of source nuclides to be evaluated (integer between 1 and 300).
- jq(k)* = the source nuclide k identification in ZAIID format (see Section III).
- aq(k)* = the atom density (atoms/cm³) of source nuclide k.
- nt* = the number of target nuclides (integer value between 1 and 20).
- nag* = the number of α -particle energy groups to be used in calculation (integer value between 1 and 4000).
- idt(i)* = the target nuclide i identification in ZAIID format (see Section III).
- at(i)* = the fraction of all atoms that are target nuclide i.

The first example demonstrates the neutron sources produced via decay in clean UO₂ fuel with 3% enriched U-235. This problem solves for the neutron source magnitudes from the homogeneous mixture. The first card is simply the title. The second card has records for *idd*=1 (homogeneous problem) and *id*=1 (neutron source magnitudes only). The third card has records for *nz*=2 (two elemental constituents: uranium and oxygen) and *isg*=0 (solid stopping power coefficients). Cards 4.1 and 4.2 include the Z-values for oxygen and uranium [*jzm*(1)=8 and *jzm*(2)=92], as well as their atom fractions [*azm*(1)=²/₃ and *azm*(2)=¹/₃]. Two source nuclides are included (*nq*=2) for U-235 and U-238 with atom densities of 6.77 x 10²⁰ and 2.16 x 10²² atoms/cm³, respectively. Card 8 includes records for *nt*=2 and *nag*=4000. Card 9.1 and 9.2 include the atom fractions for O-17 and O-18 [the (α ,n) targets in natural oxygen].

Example Problem #1 - 3% Enriched Uranium Dioxide Fuel for Neutron Source Magnitude.

Example 1 - Clean UO₂ Fuel (3% enriched)

```
1 1
2 0
   8 0.6666667
   92 0.3333333
2
  922350 6.77e+20
  922380 2.16e+22
2 4000
   80170 0.000253
   80180 0.001333
```

A second example problem using the identical material characteristics used in Example Problem #1 is shown in Example Problem #2. This problem illustrates the input necessary to develop neutron spectra outputs. The value of *id* (Card 2) has been changed to 2, and cards 5, 5.1, and 5.2 have been included to define the neutron energy spectra (these cards were omitted in Example Problem #1). The spectra have been established by user input (i.e., *nng* is negative) to span from 0.0 to 10.0 MeV in 1.0 MeV bins. The energy group width can be of any magnitude and can vary from group to group.

Example Problem #2 - 3% Enriched Uranium Dioxide Fuel for Neutron Source Magnitude and Spectra.

Example 2 - Clean UO₂ Fuel (3% enriched) for Spectra

```
1 2
2 0
   8 0.6666667
   92 0.3333333
-10 10.0 0.0
   10.0 9.0 8.0 7.0 6.0
   5.0 4.0 3.0 2.0 1.0
2
  922350 6.77e+20
  922380 2.16e+22
2 4000
   80170 0.000253
   80180 0.001333
```

Example Problem #3 - PuF₄ Gas for Neutron Source Magnitude and Spectra.

```
Example 3 - PuF4 Gaseous Problem
1 2
2 1
    9 0.8
    94 0.2
20 15.0 0.0
6
    942380 2.13e+17
    942390 2.54e+21
    942400 1.65e20
    942410 7.39e18
    942420 8.99e17
    952410 4.37e18
1 2000
    90190 0.8
```

Example Problem #3 illustrates the usage of a linearly interpolated energy structure ($nng > 0$) and gas stopping power coefficients ($isg = 1$). In this problem, the neutron source spectra and magnitudes ($id = 2$) are determined for a PuF₄ gas. This problem is reminiscent of possible criticality conditions in enrichment operations. The energy spectra have been established to include 20 groups ($nng = 20$) linearly interpolated from 15.0 ($enmax$) to 0.0 ($enmin$) MeV. The problem includes five isotopes of plutonium (Pu-238, Pu-239, Pu-240, Pu-241, and Pu-242) and one isotope of americium (Am-241) as sources ($nq = 6$). Also one isotope of fluorine (F-19) is included as an (α, n) target ($nt = 1$). Note that due to its low concentration, Am was neglected as an elemental constituent. Thus, only two elemental constituents are present (Pu and F, $nz = 2$) to slow the α -particles. Both of these elements will use gas stopping power coefficients in all calculations. The number of α -particle energy groups (nag) used was 2000.

The free-form input allows for the atom densities to be entered in any format (i.e., decimal, scientific with the + or - sign on the exponent, or scientific without the + or - on the exponent) and for spaces to be used freely to allow for easier reading by the user. Also, nuclides can be included as sources or targets and not appear as an elemental constituent.

The outputs for some of the above example problems will be presented in Appendix A. Also, several sample problems that show other input decks are described in Section VI.

B. Interface Problems (*idd=2*)

An interface problem input deck is divided into two sections, one for the source side and one for the target side. The deck must contain at least 13 cards that are used to describe the material constituents of both the source and target sides, the source nuclides present, the target nuclides present, the types of stopping cross sections to be used, the α -particle energy group structure to be used at the interface, and the neutron source energy group structure to be used in the output. The cards are described as follows:

<i>card 1:</i>	<i>title</i>
<i>card 2:</i>	<i>idd id</i>
<i>card 3:</i>	<i>nzq isgq eamax eamin</i>
<i>card 4.1 - 4.nz:</i>	<i>jzq(j) azq(j)</i>
<i>card 5:</i>	<i>naq</i>
<i>card 6:</i>	<i>nq</i>
<i>card 7.1 - 7.nq:</i>	<i>jq(k) aq(k)</i>
<i>card 8:</i>	<i>title2</i>
<i>card 9:</i>	<i>nzt isgt</i>
<i>card 10:</i>	<i>jzt(k) azt(k)</i>
<i>card 11:</i>	<i>nng enmax enmin (if necessary)</i>
<i>card 11.1 - 11.nng:</i>	<i>en(n) (if necessary)</i>
<i>card 12:</i>	<i>nt nag</i>
<i>card 13.1 - 13.nt:</i>	<i>idt(i) at(i).</i>

Multiple cards are designated by subcards (i.e., if *nz=3*, then the input deck would include cards 3, 4.1, 4.2, and 4.3). Each subcard must be entered on a new line (the exception being cards 11.1 through 11.*nng* where all records *en(n)* can be entered on the same line or multiple lines). Each record is defined as follows:

nzq = the number of stopping cross section elemental constituents present in the source material (must be an integer between 0 and 20).

isgq = the type of stopping cross sections to be used for source side (0 for solid stopping cross sections, 1 for gas stopping cross sections).

eamax = the maximum α -particle energy for α -particle source at the interface.

eamin = the minimum α -particle energy for α -particle source at interface.

jzq(k) = the atomic number of each stopping cross section elemental constituent from $j=1$ to *nzq* for the source side.

azq(k) = the fraction of all atoms on source side that are element *k*.

naq = the number of α -particle energy groups (integer between 1 and 4000) for α -particle source at the interface.

nq = the number of source nuclides to be evaluated (integer value between 1 and 300).

jq(k) = the source nuclide *k* identification in ZAID format (see Section III).

aq(k) = the fraction of all atoms on source side that are source nuclide *k*.

title2 = title record for the target side (maximum of 77 characters).

nzt = the number of stopping cross section elemental constituents present in the target material (must be an integer between 0 and 20).

isgt = the type of stopping cross sections to be used for the target side (0 for solid stopping cross sections, 1 for gas stopping cross sections).

jzt(k) = the atomic number of each stopping cross section elemental constituent from $j=1$ to *nzt* for the target side.

azt(k) = the fraction of all atoms on the target side that are element *k*.

nng = the number of neutron spectrum energy groups (integer between 1 and 750 or between -1 and -750); read only if *id=2*,

otherwise omitted. If *nng* is positive, then the energy group structure will be determined by a linear interpolation between *enmax* and *enmin* (cards 5.1 through 5.*nng* are omitted). If *nng* is negative, then the energy group upper bounds must be specified on cards 5.1 through 5.*nng* (however *enmax* and *enmin* must still be included).

enmax = the maximum neutron energy in MeV (read only if *id*=2, otherwise omitted).

enmin = the minimum neutron energy in MeV (read only if *id*=2, otherwise omitted).

en(n) = the upper energy bound in MeV of neutron groups, listed in descending order (must contain *nng* records in any format); read only if *id*=2 and *nng* is negative (otherwise omitted).

nt = the number of target nuclides (integer value between 1 and 20).

nag = the number of α -particle energy groups to be used in calculation (integer value between 1 and 4000).

idt(i) = the target nuclide *i* identification in ZAID format (see Section III).

at(i) = the fraction of all atoms on target side that are nuclide *i*.

Two example input decks are listed below. These examples illustrate the proper usage of the cards and records described above.

Example Problem #4 consists of a slab of weapons grade plutonium (WPu) adjacent to a slab of Be. The problem has *idd*=2 to signify an interface problem and *id*=2 for a magnitudes and spectra solution. The WPu consists of 5 isotopes of Pu (Pu-238, Pu-239, Pu-240, Pu-241, and Pu-242) and one isotope of Am (Am-241) as a contaminant. Thus, *nzq*=2 (for Pu and Am), and *nq*=6 (for the six isotopes of Pu and Am). Solid-stopping cross sections were used for both the source and target side (*isgq*=*isgt*=0). The α -particle energy structure at the interface consists of 100 groups linearly interpolated between 6.50 and 0.0000001 MeV. The target is composed of beryllium metal, thus *nzt*=1

and $nt=1$ (for Be-9 only). The neutron energy group structure is defined to contain 20 groups linearly interpolated between 10.0 and 0.0 MeV.

Example Problem #5 models a problem with a pure Am-241 source material interfaced with an AlB_2 plate. This example solves for the neutron source magnitudes only ($id=1$) using only Am-241 as the source material ($nzq=1$). The target material is made of Al and B ($nzt=2$). Note that the elemental constituents can be entered in any order [i.e., Al ($Z=13$) before B ($Z=5$)]; however, the target isotopes must be in increasing ZAID order. Three (α,n) target isotopes are present: B-10, B-11, and Al-27. The outputs for all of the above examples will be presented in Appendix A. Several sample problems that show other input decks are described in Section VI.

Example Problem #4 - Weapons Grade Pu-Be Interface Source Calculation for Magnitudes and Spectra.

Example 4 - WPu-Be Interface Problem

```
2 2
2 0 6.50 0.0000001
  94 0.9998
  95 0.0002
100
6
  942380 0.0005
  942390 0.9233
  942400 0.0650
  942410 0.0100
  942420 0.0010
  952410 0.0002
target is composed of Be
1 0
  4 1.0
20 10.0 0.0
1 4000
  40090 1.0
```

Example Problem #5 - Am-AlB₂ Interface Calculation for Neutron Source Magnitudes and Spectra.

```
Example 5 - Am-AlB2 Interface Problem
2 1
1 0 6.50 0.000001
  95 1.0
52
1
  952410 1.00
target is composed of AlB2
2 0
  13 0.333333
  5 0.666667
3 4000
  50100 0.132667
  50110 0.534000
  130270 0.333333
```

C. Beam Problems (*idd=3*)

The input deck for a beam problem is traditionally simpler than that for an interface or homogeneous problem because the problem is devoid of any source nuclides to describe. A beam problem must contain at least eight cards that describe the elemental constituents in the material, the neutron energy group structure to be used in the output, the α -particle beam energy, the type of stopping cross sections to be used, and the (α,n) target nuclides present. If multiple materials are present or a neutron energy spectrum is requested, then more cards can exist in the input deck. Cards 1–8 are as follows:

<i>card 1:</i>	<i>title</i>
<i>card 2:</i>	<i>idd id</i>
<i>card 3:</i>	<i>nz isg</i>
<i>card 4.1 - 4.nz:</i>	<i>jzm(j) azm(j)</i>
<i>card 5:</i>	<i>nng enmax enmin (if necessary)</i>
<i>card 5.1 - 5.nng:</i>	<i>en(n) (if necessary)</i>
<i>card 6:</i>	<i>ebeam</i>
<i>card 7:</i>	<i>nt nag</i>
<i>card 8.1 - 8.nt:</i>	<i>idt(i) at(i)</i>

Note that multiple cards are designated by subcards (i.e., if $nz=3$, then the input deck would include cards 3, 4.1, 4.2, and 4.3). Each subcard must be entered on a new line

(the exception being cards 5.1 through 5.*nng* where all records *en(n)* can be entered on the same line or multiple lines). Each record is defined as follows:

- nz* = the number of stopping cross section elemental constituents present in the material (must be an integer between 0 and 20).
- isg* = the type of stopping cross sections to be used (0 for solid stopping cross sections, 1 for gas stopping cross sections).
- jzm(j)* = the atomic number of each stopping cross section elemental constituent from $j = 1$ to *nz*.
- azm(j)* = the fraction of all atoms that are element *j*.
- nng* = the number of neutron spectrum energy groups (integer between 1 and 750 or between -1 and -750); read only if *id=2*, otherwise omitted. If *nng* is positive, then the energy group structure will be determined by a linear interpolation between *enmax* and *enmin* (cards 5.1 through 5.*nng* are omitted). If *nng* is negative, then the energy group upper bounds must be specified on cards 5.1 through 5.*nng* (however *enmax* and *enmin* must still be included).
- enmax* = the maximum neutron energy in MeV (read only if *id=2*, otherwise omitted).
- enmin* = the minimum neutron energy in MeV (read only if *id=2*, otherwise omitted).
- en(n)* = the upper energy bound in MeV of neutron groups, listed in descending order (must contain *nng* records in any format); read only if *id=2* and *nng* is negative (otherwise omitted).
- ebeam* = the α -particle beam energy in MeV.
- nt* = the number of target nuclides (integer value between 1 and 20).
- nag* = the number of α -particle energy groups to be used in calculation (integer value between 1 and 4000).
- idt(i)* = the target nuclide *i* identification in ZAID format (see Section III).

$at(i) =$ the fraction of all atoms that are target nuclide i .

Example Problem #6 below illustrates the procedure described above. This beam problem ($idd=3$) consists of a slab of silicon dioxide bombarded by 5.5 MeV α -particles ($ebeam=5.5$). Solid stopping cross section values ($isg=0$) are used for the two elemental constituents ($nz=2$) present in the problem (Si and O). The problem solves for the neutron source magnitudes and spectra ($id=2$) resulting from four ($nt=4$) target isotopes (O-17, O-18, Si-29, and Si-30). The outputs for this problem will be presented in Section V. Also several sample problems that show other input decks are described in Section VI.

Example Problem #6 - 5.5 MeV α -particle Beam Incident on a Slab of Silicon Dioxide.

```
Example 6 - Alpha Beam (5.5 MeV) on SiO2
3 2
2 0
      8 0.666667
      14 0.333333
-22 10.0 0.0
    10.00 7.00 6.00 5.50 5.00 4.50 4.00 3.50 3.25
      3.00 2.75 2.50 2.25 2.00 1.75 1.50 1.25 1.00
      0.75 0.50 0.25 0.10
5.5
4 4000
    80170 0.000253
    80180 0.001333
    140290 0.015567
    140300 0.010333
```

D. Three Region Interface Problems ($idd=4$)

A three-region interface problem input deck is divided into four sections. The first section contains information regarding the energy and angular grids to be used in the calculations. The remaining three sections pertain to each of the three slab regions. The deck must contain at least 15 cards that are used to describe the α -particle energy grid at each interface, the neutron energy grid for the output, the angular grid, material constituents for all regions, the source nuclides present, the target nuclides present, and the types of stopping cross sections to be used. The cards are described as follows:

card 1: *title*

card 2: *idd id*
card 3: *nag eamax eamin*
card 4: *nng enmax enmin* (if necessary)
card 4.1 - 4.nng: *en(n)* (if necessary)
card 5: *ncg*
card 6: *title1*
card 7: *nza isga*
card 8.1 - 8.nza: *jza(j) aza(j)*
card 9: *nq*
card 10.1 - 10.nq: *jq(k) aq(k)*
card 11: *title2*
card 12: *nzb isgb anumbr t*
card 13: *jzb(k) azb(k)*
card 14: *ntb*
card 15.1 - 15.ntb: *idb(i) atb(i)*
card 11: *title3*
card 12: *nzc isgc*
card 13: *jzc(k) azc(k)*
card 14: *ntc*
card 15.1 - 15.ntc: *idc(i) atc(i)*

Multiple cards are designated by subcards (i.e., if *nza=3*, then the input deck would include cards 7, 8.1, 8.2, and 8.3). Each subcard must be entered on a new line (the exception being cards 4.1 through 4.*nng* where all records *en(n)* can be entered on the same line or multiple lines). Each record is defined as follows:

nag = the number of α -particle energy groups (integer between 1 and 4000) for α -particle source at each interface.
eamax = the maximum α -particle energy for α -particle source at each interface.
eamin = the minimum α -particle energy for α -particle source at each interface.

nng = the number of neutron spectrum energy groups (integer between 1 and 750 or between -1 and -750); read only if *id*=2, otherwise omitted. If *nng* is positive, then the energy group structure will be determined by a linear interpolation between *enmax* and *enmin* (cards 4.1 through 4.*nng* are omitted). If *nng* is negative, then the energy group upper bounds must be specified on cards 4.1 through 4.*nng* (however *enmax* and *enmin* must still be included).

enmax = the maximum neutron energy in MeV (read only if *id*=2, otherwise omitted).

enmin = the minimum neutron energy in MeV (read only if *id*=2, otherwise omitted).

en(n) = the upper energy bound in MeV of neutron groups, listed in descending order (must contain *nng* records in any format); read only if *id*=2 and *nng* is negative (otherwise omitted).

ncg = the number of α -particle angular groups (integer between 1 and 4000) for α -particle source at each interface.

title1 = title record for the region A (maximum of 77 characters).

nza = the number of stopping cross sections elemental constituents in region A (up to 20).

jza(k) = the atomic number of each stopping cross section elemental constituent from *j* = 1 to *nza* for the region A.

aza(k) = the fraction of all atoms in region A that are element *k*.

nq = the number of source nuclides to be evaluated (integer value between 1 and 300).

jq(k) = the source nuclide *k* identification in ZAID format (see Section III).

aq(k) = the fraction of all atoms in region A that are source nuclide *k*.

title2 = title record for the region B (maximum of 77 characters).

- nzb* = the number of stopping cross section elemental constituents present in region B (must be an integer between 0 and 20).
- isgb* = the type of stopping cross sections to be used for the target side (0 for solid stopping cross sections, 1 for gas stopping cross sections).
- anumb* = the atomic number density of all materials in region B (in atoms/b-cm)
- t* = the thickness (in cm) of region B.
- jzb(k)* = the atomic number of each stopping cross section elemental constituent from $j=1$ to *nzb* in region B.
- azb(k)* = the fraction of all atoms in region B that are element k.
- ntb* = the number of target nuclides (integer value between 1 and 20).
- idb(i)* = the target nuclide i identification in ZAID format (see Section III) for targets in region B.
- atb(i)* = the fraction of all atoms in region B that are nuclide i.
- title3* = title record for the region B (maximum of 77 characters).
- nzc* = the number of stopping cross section elemental constituents present in region B (must be an integer between 0 and 20).
- isgc* = the type of stopping cross sections to be used for the target side (0 for solid stopping cross sections, 1 for gas stopping cross sections).
- jzc(k)* = the atomic number of each stopping cross section elemental constituent from $j=1$ to *nzb* in region B.
- azc(k)* = the fraction of all atoms in region B that are element k.
- ntc* = the number of target nuclides (integer value between 1 and 20).
- idc(i)* = the target nuclide i identification in ZAID format (see Section III) for targets in region B.
- atc(i)* = the fraction of all atoms in region B that are nuclide i.

Two example input decks are listed below. These examples illustrate the proper usage of the cards and records described above.

The first example problem consists of a slab of weapons grade plutonium (WPu) adjacent to a slab of Be with a thin layer of Al for region B. The problem has $idd=4$ to signify a three-region interface problem and $id=2$ for a magnitudes and spectra solution. The WPu consists of 5 isotopes of Pu (Pu-238, Pu-239, Pu-240, Pu-241, and Pu-242) and one isotope of Am (Am-241) as a contaminant. Thus, $nzq=2$ (for Pu and Am), and $nq=6$ (for the six isotopes of Pu and Am). Solid-stopping cross sections were used for all regions ($isga=isgb=isgc=0$). The α -particle energy structure at each interface consists of 400 groups linearly interpolated between 6.50 and 0.0000001 MeV. Region B is composed of Al metal [$nzb=1$ and $ntb=1$ (for Al-27 only)] with a density of 0.15 atoms/b-cm and a thickness of 1 mm. Region C is composed of beryllium metal, thus $nzc=1$ and $ntc=1$ (for Be-9 only). The neutron energy group structure is defined to contain 20 groups linearly interpolated between 10.0 and 0.0 MeV. Forty angular groups are used at each interface ($ncg=40$).

Example Problem #7 - Weapons Grade Pu-Al-Be Interface Source Calculation for Magnitudes and Spectra.

```

Example #7 (WPu-Al-Be)
4 2
400 6.5 0.0000001
20 10.0 0.0
40
WPu region
2 0
  94 0.9998
  95 0.0002
6
  942380 0.0005
  942390 0.9233
  942400 0.0650
  942410 0.0100
  942420 0.0010
  952410 0.0002
Al interface
1 0 0.5 0.1
  13 1.0
1
  130270 1.0
Be reflector
1 0
  4 1.0
1
  40090 1.0

```

Example Problem #8 models a problem with a pure Am-241 source material interfaced with an AlB_2 plate with a small (3.0 cm thick) CO_2 gap. This example solves

for the neutron source magnitude and spectra ($id=2$) using only Am-241 as the source material ($nza=1$). Region B consists of two elements ($nzb=2$) and three (α,n) target nuclides ($ntb=3$). Gas stopping powers are used in region B ($isgb=1$). The target material in region C is made of Al and B ($nzc=2$). Note that the elemental constituents can be entered in any order [i.e., Al ($Z=13$) before B ($Z=5$)]; however, the target isotopes must be in increasing ZAID order. Three (α,n) target isotopes are present in region C: B-10, B-11, and Al-27. The outputs for all of the above examples will be presented in Appendix A.

Example Problem #8 - Am-CO₂-AlB₂ Interface Calculation for Neutron Source Magnitudes and Spectra.

Example 8 - Am-CO₂-AlB₂ Interface Problem

```

4 2
400 6.5 0.0000001
20 10.0 0.0
60
Pure Am-241 in region A
1 0
  95 1.0
1
  952410 1.0
CO2 gas in region B
2 1 0.004 3.0
  6 0.333
  8 0.667
3
  60130 0.0073333
  80170 0.0002667
  80180 0.0013333
AlB2 shield in region C
2 0
  13 0.33333
  5 0.66667
3
  50100 0.132667
  50110 0.534000
  130270 0.333333

```

E. Execution

To execute the SOURCES 4A code, one needs to run the executable file. The input deck must be named *tape1*, and the library files must be named *tape2* through *tape5*. After execution, SOURCES 4A will display a STOP message informing the user whether

the code was executed normally or if any errors existed during execution. In most cases, the SOURCES 4A STOP message will inform the user of the cause of any execution error.

If any errors occur during execution, the user should first check the file *outp* that is created during SOURCES 4A execution (see Section V). *outp* contains a summary of all input read from *tape1*. The majority of all errors from SOURCES 4A are from an improperly constructed input deck. If no errors exist in the input deck, then the next most common error occurs when SOURCES 4A attempts to run a problem for which isotopic data does not exist. The user should recheck the ZAIID specified in *tape1* with the isotopes listed in Tables I and II. The users should only make modifications to the library files as a last resort to correcting any errors.

V. DESCRIPTION OF OUTPUT

Depending upon the neutron source output requested, SOURCES 4A can create between two and five output files. If the input deck specifies a magnitudes only problem ($id=1$), then only two output files, *outp* and *tape6*, are created. If the neutron source spectra ($id=2$) is requested in the input deck (*tape1*), then all the files specified in Section III are created (*tape6* to *tape9* and *outp*). The exception being for interface problems in which the file *tape9* is not created. This is because the source α -particles on the target side may have numerous groups and would make the file extremely large. Each output file has a header summarizing the contents of each file and a card listing the problem title.

The file *outp* contains a summary of the input deck as read by SOURCES 4A and of all output decks created by SOURCES 4A. The user should always check this file after running SOURCES 4A to ensure that all input was read as intended. The file *outp* also lists the neutron source strengths and average energies by decay mode and total for all modes. Lastly, *outp* shows the portion of the neutron source rates included in the neutron spectrum calculations [for total, (α,n), spontaneous fission, and delayed neutron, when necessary]. In other words, the ratio of the neutron source magnitude, calculated by a summation over all energy groups, to the total calculated neutron source magnitude. This value is a measure of how well the energy structure was chosen. If the value is below a certain percentage ($\sim 90\%$), the energy structure may have been chosen with *enmax* significantly less than the maximum neutron energy produced in the system. In this case, the user may want to choose a different energy structure with a larger group 1 upper-bound.

The *tape6* file lists the neutron source magnitudes by target nuclide and by source α -particle. The file contains up to three tables labeled Table I, Table II, and Table III. These tables report the neutron production rates from (α,n) reactions, spontaneous fission, and delayed neutron emission in that order. The tables have appropriate headings for the neutron production parameters with units included. The *outp* and *tape6* files for the input deck in Example Problems #1, #2, #4, and #6 are listed in Appendix A.

The *tape7* file lists the absolute neutron spectra (i.e., neutrons per second per unit volume per unit energy). This file first lists the multigroup neutron spectra (i.e., the energy bounds) used in the calculations in decreasing order. The absolute neutron spectra listed by neutron/target combination is then displayed in order coinciding with the group structure specified at the beginning of the file. Totals per target nuclide for (α,n) reactions, totals for all (α,n) reactions, totals for spontaneous fission neutrons, and totals for delayed neutrons are also listed (if applicable). The file *tape8* is similar to *tape7* except that normalized neutron spectra are reported. *Tape9* lists the energy dependent neutron production rates by target nuclide and by product nuclide level. Again, the neutron energy group structure is first listed and then a breakdown of the neutron energy spectra with target nuclide totals is reported. The *tape7* output files corresponding to the input files listed in Example Problems #2, #4, and #6 are included in Appendix A, as well as the *tape9* output files for Example Problems #2 and #4.

VI. SAMPLE PROBLEMS

Several sample problems are listed below. These problems are available to aid the user in construction of the input deck (*tape1*). The problems were executed to model experimental arrangements, and measured data are reported with the SOURCES 4A calculation when available.

A. Homogeneous Mixtures

1. Sample Problem #1

This problem illustrates the neutron source magnitudes and spectra from a PuBe_{13} source (elemental constituents are $^{13}_{14}\text{Be}$ and $^1_{14}\text{Pu}$) with six isotopes of Pu (Pu-237, Pu-238, Pu-239, Pu-240, Pu-241, and Pu-242) and one isotope of Be (Be-9) present. The example solves for the magnitude and spectra ($id=2$) and uses a 48 group neutron energy structure ($nng=48$) which is linearly interpolated between 12.0 ($enmax$) and 0.0 ($enmin$) MeV. The six Pu isotopes are used as sources ($nq=6$), and the one beryllium isotope is the target ($nt=1$). The atom fractions and densities can be entered in scientific notation or decimal notation. This input deck is an appropriate model of the experimental measurement performed by L. Stewart.¹⁴

```
Sample 1 - PuBe13 Source (Stewart, 1953)
1 2
2 0
   4 0.928571
   94 0.071429
48 12.0 0.0
6
   942370 13144.0
   942380 7.08e+17
   942390 5.82e+21
   942400 3.74e+20
   942410 1.69e+19
   942420 1.22e+18
1 4000
   40090 0.928571
```

Fig. 8. Sample Problem #1 Input Deck.

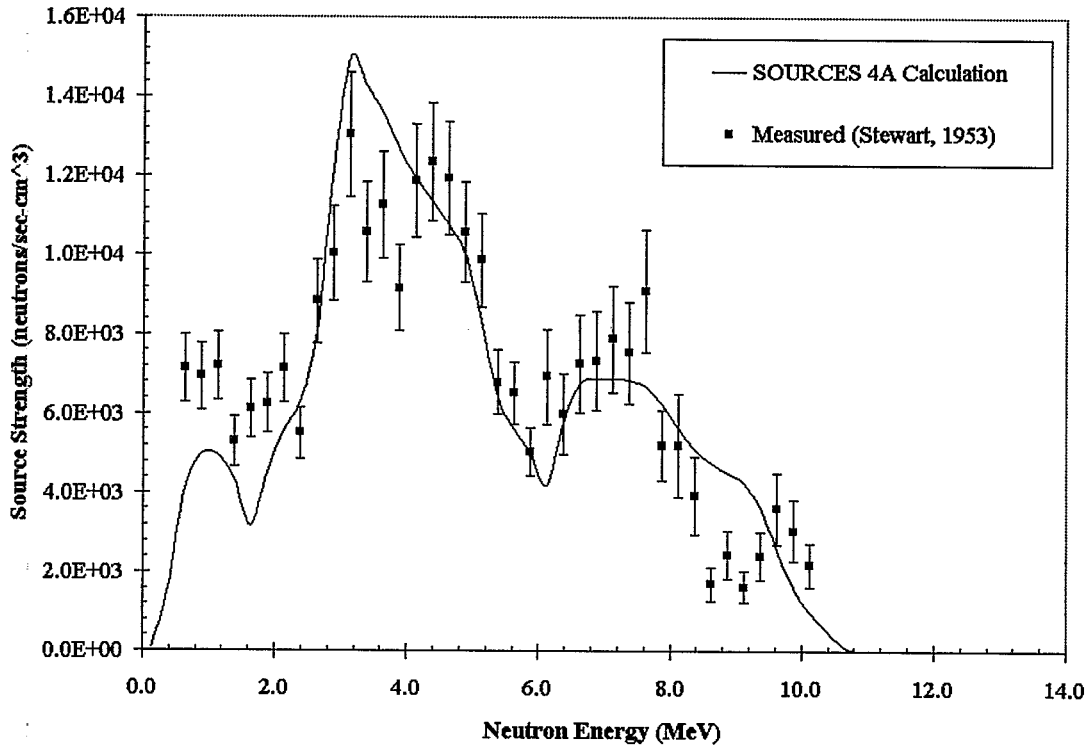

Fig. 9. Energy-Dependent Neutron Source Strength in PuBe₁₃ Homogeneous Problem as Calculated by SOURCES 4A and Compared with Measured Data.

A comparison of the data measured by the experimenters and the SOURCES 4A calculation is presented in Fig. 9. To construct this plot, the histogram output from SOURCES 4A was converted to a continuous distribution using the midpoint energy for each energy group. This conversion was repeated for all energy-dependent neutron source plots in this section (i.e., Figs. 8, 11, 14, 16, 18, and 20). The total neutron source magnitude calculated by SOURCES 4A was 2.69×10^5 neutrons/s-cm³, whereas the experimenters reported a total neutron source rate of 2.28×10^5 neutrons/s-cm³. This magnitude of agreement ($\pm 17\%$) is standard for a SOURCES 4A calculation. From Fig. 9, reasonable agreement between the SOURCES 4A spectrum calculation and the measured values is found. The calculation neglected any source contaminants (esp., Am-241), because they were not specified in the published experiment.

2. Sample Problem #2

Several experiments have been performed to analyze criticality accidents involving uranium-containing solutions. These experiments have been primarily interested in gross measurements of k_{eff} . However, in 1991 a measurement was performed by Seale and Andersen¹⁵ to record neutron production rates from uranyl fluoride and uranyl nitrate. The researchers' data for uranyl fluoride was found to be reproducible in several different samples, all of different total volumes. Thus, the uranyl fluoride experiment was chosen for modeling by SOURCES 4A. A calculation was performed using the data listed by the experimenters. The solution was uranyl fluoride (UO_2F_2) with a density of 2.16 g/ml. The uranium concentration consisted of 5% U-235 by weight. The SOURCES 4A input deck for this problem is listed in Fig. 10. The source nuclides included U-234, U-235, and U-238. No contaminants were listed by the researchers; thus, none were included in the calculation. The three (α, n) target nuclides shown are O-17, O-18, and F-19. O-16 was not included because of its negligible (α, n) reaction cross section. The problem was executed, and SOURCES 4A reported a neutron production rate of 0.0469 neutrons/s-cm³. The experimenters had measured a neutron production rate of 0.0421 ± 0.0016 neutrons/s-cm³. This yields a discrepancy between the SOURCES 4A calculation and the experimentally measured value of 11.5%. This is generally considered good agreement for this type of calculation.

```
Sample 2 - Uranyl-Fluoride Solution (Seale, 1991)
1 1
3 0
    8 0.4
    9 0.4
   92 0.2
3
  922340 1.32e+17
  922350 2.11e+20
  922380 4.01e+21
3 4000
  80170 0.000152
  80180 0.0008
  90190 0.4
```

Fig. 10. Sample Problem #2 Input Deck.

```

Sample 3 - PoBe Source (Speck, 1944)
1 2
2 0
      4 0.99999886
      84 0.00000114
60 12.0 0.0
1
      842100 6.38e+16
1 4000
      40090 0.99999886

```

Fig. 11. Sample Problem #3 Input Deck.

3. Sample Problem #3

Using the photographic emulsion method, researchers at Los Alamos National Laboratory measured the neutron energy spectrum from a Po-Be source.¹⁶ The source was a mixture of Po and Be metals in the shape of a cylinder $\frac{3}{8}$ " in diameter and $\frac{1}{4}$ " in height. The total source activity was reported by the researchers as 100 mCi. This source configuration was modeled as a homogeneous source problem using SOURCES 4A. The input deck (*tape1*) used in this calculation is shown in Fig. 11. The problem was executed to acquire the neutron source energy spectrum plotted in Fig. 12.

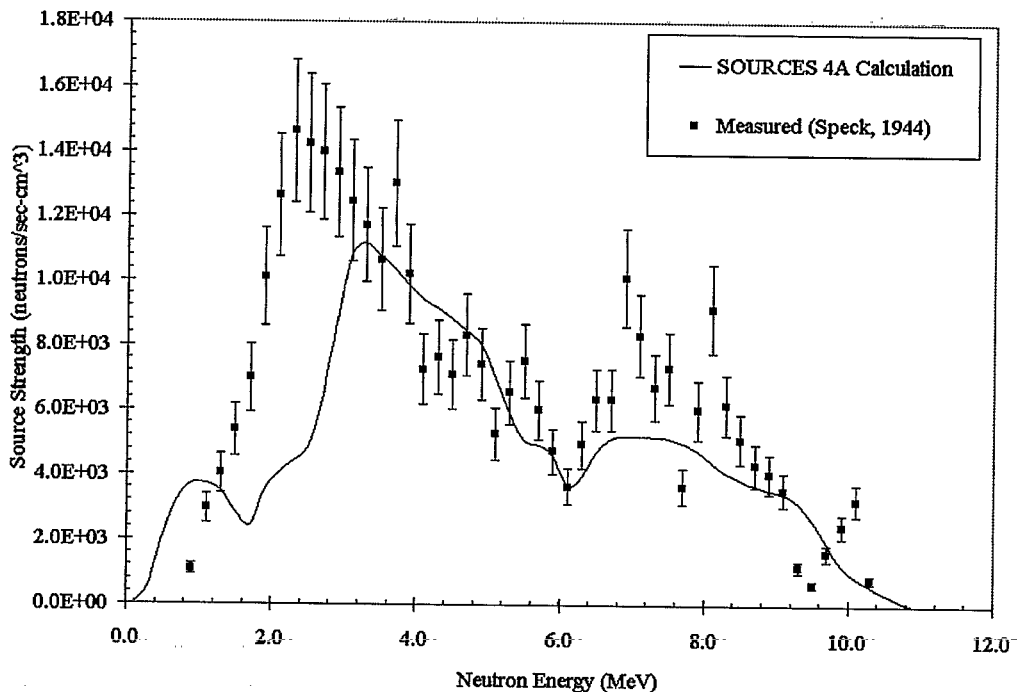

Fig. 12. Energy-Dependent Neutron Source Strength in Po-Be Homogeneous Problem as Calculated by SOURCES 4A and Compared to Measured Data.

An analysis of the data in Fig. 12 shows that the SOURCES 4A calculation appears to overestimate the average neutron energy produced from the sample. On further analysis, it can be found that a Po-Be source, though a mixture of α -emitting material and (α ,n) target material, is composed of grains of Po and grains of Be. These grains have an average diameter significantly larger than the α -particle range. Thus, it is postulated that a Po-Be source is more properly modeled as an interface problem of Po and Be. This theory is supported by the calculations performed in Sample Problem #5.

The outcome of this problem is extremely important. A SOURCES 4A user must be aware of the physics inherent in any problem being modeled. In the case of Sample Problems #1 and #2, the materials were compounds (PuBe_{13} or UO_2F_2). Thus, the α -emitting nuclides and (α ,n) target nuclides are intimately mixed. For Po-Be, the material has a tendency to clump into grains, and the grain size of the metals can and will affect the outcome of the calculations. Therefore, it is imperative that a user analyze the chemical nature of any problem under consideration prior to constructing the input deck.

B. Interface Problem Examples

1. Sample Problem #4

In 1944, a study was conducted by Perlman *et al.*¹⁷ at Los Alamos National Laboratory to explore the possibility of using an (α ,n) neutron source to simulate a fission neutron spectra. In this study, a series of platinum foils (3 x 3 cm in size) were coated with 180 mCi of Po and then interleaved between sintered B_4C slabs. The entire Po- B_4C assembly was placed in a brass box and sealed under a slight vacuum. The resultant neutron energy spectra from the source was measured using the photographic emulsion method. A schematic of the experimental setup is shown in Fig. 13.

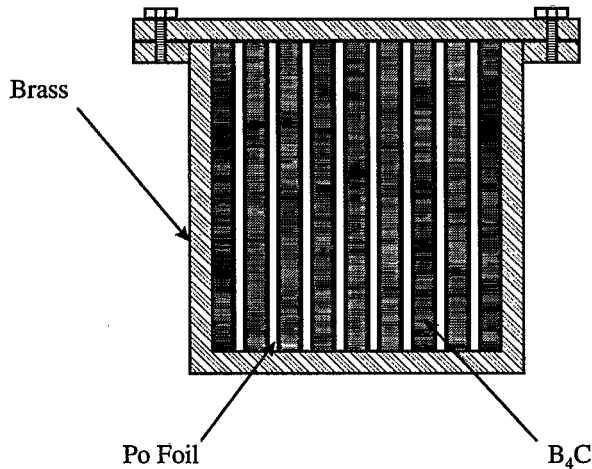

Fig. 13. Po-B₄C Source Arrangement for Sample Problem #4.

To model this arrangement, a SOURCES 4A input deck (Fig. 14) was constructed which employed the interface problem capabilities of SOURCES 4A (*idd=2*). The atomic fractions listed in the input deck show that natural boron (19.9% B-10 and 80.1% B-11) and carbon (98.9% C-12 and 1.1% C-13) were used. Also the α -particle source was set to include 100% Po-210. This input deck was executed to solve for the neutron source spectra and magnitudes (*id=2*) resulting from the (α ,n) interactions in the boron carbide.

```

Sample 4 - Po-B4C Interface Experiment (Perlman, 1944)
2 2
1 0 10.0 0.0000001
      84 1.0
50
1
  842100 1.00
target is a B4C slab
2 0
      5 0.8
      6 0.2
50 10.0 0.0
3 4000
  50100 0.1592
  50110 0.6408
  60130 0.0022

```

Fig. 14. Sample Problem #4 Input Deck.

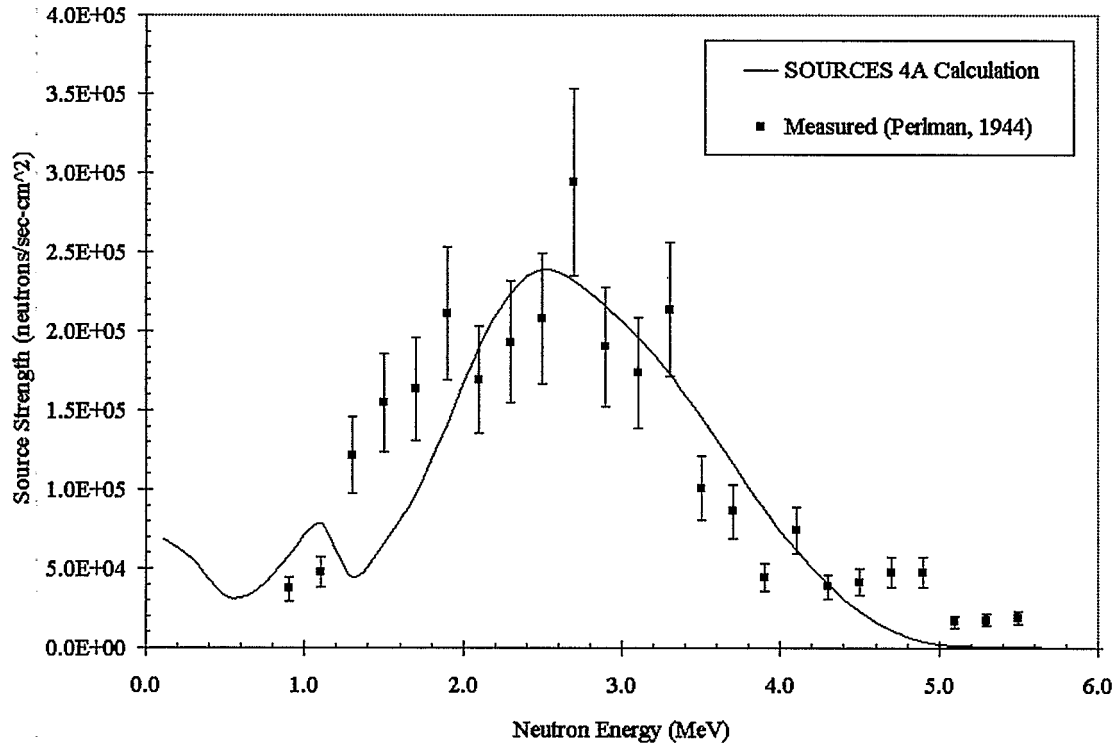

Fig. 15. Energy-Dependent Neutron Source Strength in Po-B₄C Interface Problem as Calculated by SOURCES 4A and Compared to Measured Data.

The energy spectrum of the calculated Po-B₄C neutrons is plotted in Fig. 15, along with the measured data. The agreement between the measured data and the SOURCES 4A calculation is reasonable and typical of an interface problem. The addition of contaminants and other Po isotopes could greatly affect the shape of this spectrum. It is important to note that the researchers did not specify the presence of any contaminants in the samples.

2. Sample Problem #5

In Sample Problem #3, a Po-Be source was investigated as a possible homogeneous problem. It was discovered that the energy spectrum of the neutrons calculated by SOURCES 4A was shifted to a higher average energy than what was reported by the experimenters.¹⁶ It was suggested that this shift was due to the grain structure of the materials in Po-Be sources. To verify this hypothesis, SOURCES 4A was used to model

the identical experiment using its interface capabilities. The Po-Be input deck used for this model is shown in Fig. 16. The figure shows that the entire source side is composed of Po-210, and the entire target side is composed of a Be-9. The neutron energy group structure is the same as that used in Sample Problem #3.

```

Sample 5 - Po-Be Interface Experiment (Speck, 1944)
2 2
1 0 10.0 0.000001
      84 1.0
50
1
      842100 1.00
target is a Be slab
1 0
      4 1.0
60 12.0 0.0
1 4000
      40090 1.0

```

Fig. 16. Sample Problem #5 Input Deck.

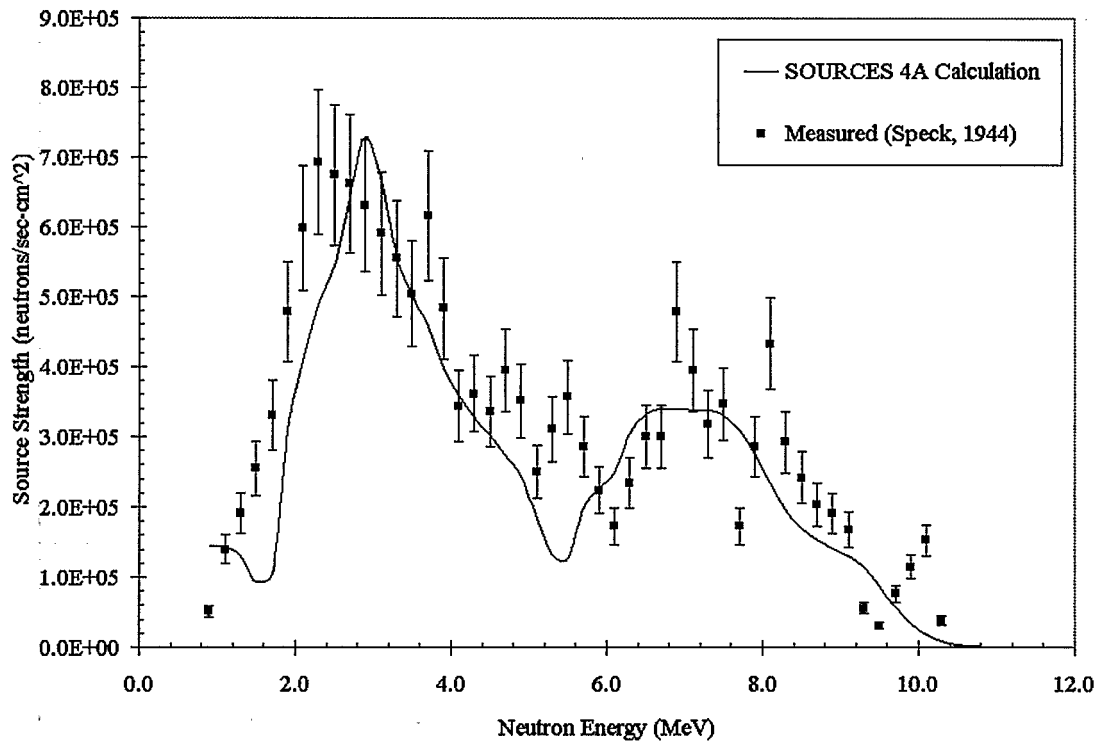

Fig. 17. Energy-Dependent Neutron Source Strength in Po-Be Interface Problem as Calculated by SOURCES 4A and Compared to Measured Data.

The output from the execution of Sample Problem #5 was plotted versus the data given by the experimenters (Fig. 17). The SOURCES 4A calculation and the measured values appear to agree to within a good degree of accuracy. This yields confirmation that a Po-Be (α,n) source is affected by the grain structure of its metal components. It is important that any SOURCES 4A users consider this type of problem when modeling any realistic (α,n) sources.

C. Beam Problem Examples

In 1983, researchers in Belgium used a 7 MV Van de Graaff accelerator and an NE213 liquid scintillator to analyze the energy spectra of neutrons produced by 4 to 5.5 MeV α -particles on thick targets of light elements (e.g., C, O, Mg, F, Al, Si, Al₂O₃, and SiO₂).¹⁸ The experimenters measured the energy spectra of neutrons in 0.1 MeV bins and reported these spectra, the total neutron yields per incident α -particle, and the average neutron energies for each sample. Two samples bombarded by the experimenters are modeled below using SOURCES 4A. The first sample was aluminum oxide (Sample Problem #6) and the second sample was pure magnesium (Sample Problem #7). The measured and calculated data for each are plotted in Figs. 19 and 21. Also, the average neutron energy and the total neutron yield per incident α -particle is reported.

1. Sample Problem #6

The input deck used for modeling the bombardment of aluminum oxide by 5.0 MeV α -particles is listed in Fig. 18. The energy structure is divided into 45 bins of 0.1 MeV width; however, the lower energy cutoff is above 0.0 MeV.

```

Sample 6 - Alpha Beam (5.0 MeV) on Al2O3
3 2
2 0
      8 0.6
     13 0.4
55 5.55 0.05
5.0
3 4000
-80170 0.000228
 80180 0.0012
130270 0.4

```

Fig. 18. Sample Problem #6 Input Deck.

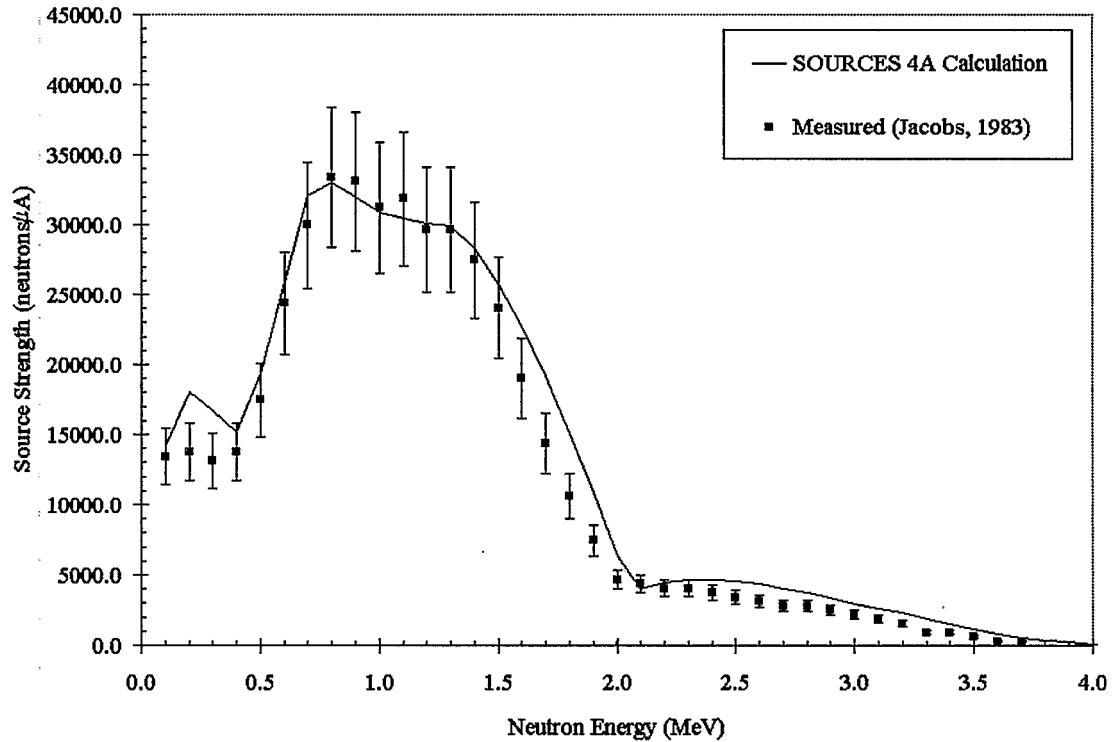

Fig. 19. Energy-Dependent Neutron Source Strength from 5.0 MeV α -Particles Incident on Aluminum Oxide Slab as Calculated by SOURCES 4A and Compared to Measured Data.

The total neutron yield per incident α -particle was reported by the experimenters to be 1.58×10^{-7} neutrons/ α -particle.¹⁸ The SOURCES 4A calculation output a value of 1.63×10^{-7} neutrons/ α -particle. The measured average neutron energy was 1.14 ± 0.04 MeV whereas SOURCES 4A reported an average energy of 1.35 MeV. As can be seen, the total neutron yields agree to within 4%. The energy-dependent neutron spectra are plotted in Fig. 18. The neutron spectra have a few small discrepancies, and the average neutron energies show an 18% difference; however the agreement is generally very good. The SOURCES 4A total neutron yields consistently have better agreement to measured data than the spectral calculations. However, as is shown here and in Sample Problem #7, for beam problems the SOURCES 4A calculations are excellent for both magnitudes and spectra.

2. Sample Problem #7

The input deck used for modeling the magnesium irradiation by 5.5 MeV α -particles is shown in Fig. 20. The magnesium sample contains two naturally occurring isotopes (Mg-25 and Mg-26) as (α ,n) target nuclides. The isotope Mg-24 was neglected due to its negligible (α ,n) cross section. The neutron energy group structure consisted of 81 energy groups in 0.1 MeV bins.

```
Sample 7 - Alpha Beam (5.5 MeV) on Mg
3 2
1 0
      12 1.0
81 8.15 0.05
5.5
2 4000
  120250 0.10
  120260 0.1101
```

Fig. 20. Sample Problem #7 Input Deck.

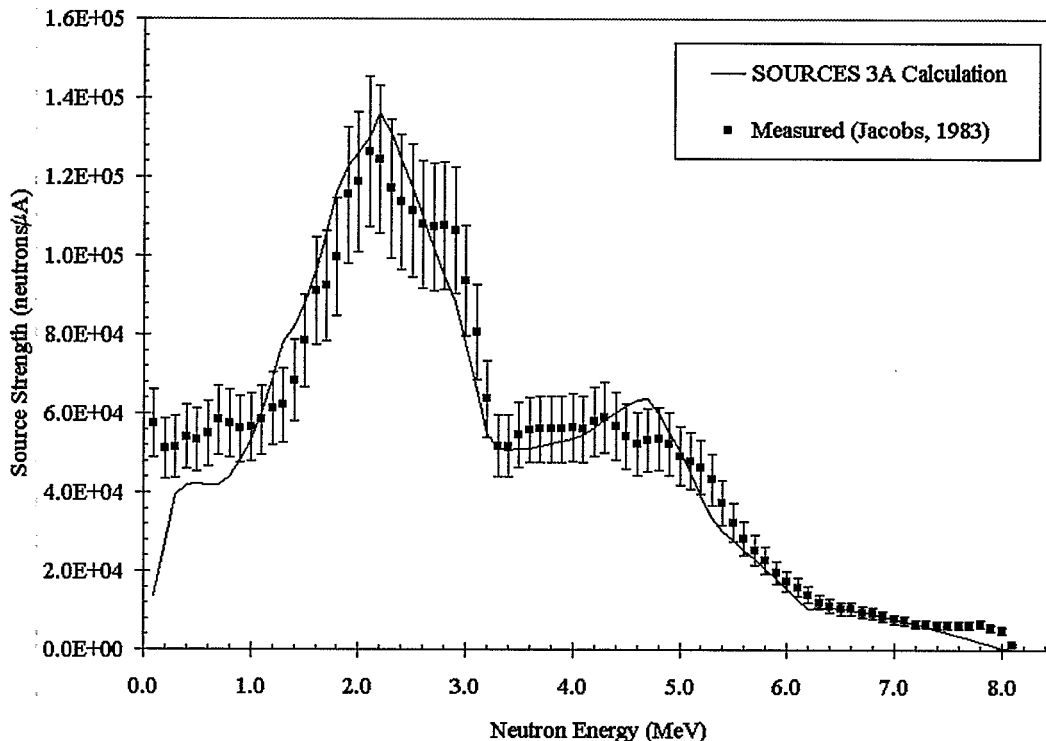

Fig. 21. Energy-Dependent Neutron Source Strength from 5.5 MeV α -Particles Incident on Magnesium Slab as Calculated by SOURCES 4A and Compared to Measured Data.

The total neutron yield per incident α -particle was reported by the experimenters to be 1.33×10^{-6} neutrons/ α -particle.¹⁸ The SOURCES 4A calculation output a value of 1.27×10^{-6} neutrons/ α -particle. The measured average neutron energy was 2.85 ± 0.12 MeV, where as SOURCES 4A reported an average energy of 3.04 MeV. The total neutron yields agree to within 5%. The energy-dependent neutron spectra are plotted in Fig. 21. The measured and calculated neutron energy spectra have excellent agreement (within experimental error).

VII. ACKNOWLEDGMENTS

The authors would like to acknowledge the aid given by J. Devaney in the derivation of the theory behind the (α, n) interface problem.

VIII. REFERENCES

1. R. T. PERRY and W. B. WILSON, "Neutron Production from (α ,n) Reactions and Spontaneous Fission in ThO₂, UO₂ and (U,Pu)O₂ Fuels," Los Alamos National Laboratory report LA-8869-MS (1981). [included in Appendix D]
2. W. B. WILSON, R. T. PERRY, J. E. STEWART, T. R. ENGLAND, D. G. MADLAND, and E. D. ARTHUR, "Development of the SOURCES Code and Data Library for the Calculation of Neutron Sources and Spectra from (α ,n) Reactions, Spontaneous Fission, and β^- Delayed Neutrons," Los Alamos National Laboratory report LA-9841-PR, page 65 (1983).
3. H. J. HIRSCH and H. J. MATZKE, "Stopping Power and Range of α -Particles in (U,Pu)C and UC and Application to Self-Diffusion Measurements Using Alpha Spectroscopy," *J. of Nucl. Mater.* **45**, page 29 (1972).
4. W. H. BRAGG and R. KLEEMAN, "On the Alpha Particles of Radium and their Loss of Range in Passing through Various Atoms and Molecules," *Phil. Mag.* **10**, page 318 (1905).
5. B. G. WHITMORE and W. B. BAKER, "The Energy Spectrum of Neutrons from a Po-Be Source," *Phys. Rev.* **78**, page 799 (1950).
6. J. H. GIBBONS and R. L. MACKLIN, "Total Neutron Yields from Light Elements Under Proton and Alpha Bombardment," *Phys. Rev.*, **114**, page 571 (1959).
7. K. W. GEIGER and L. VAN DER ZWAN, "An Evaluation of the ⁹Be(α ,n) Cross Section Data," *Nucl. Instr. and Methods* **131**, page 315 (1975).

8. J. K. BAIR and J. GOMEZ DEL CAMPO, "Neutron Yields from Alpha Particle Bombardment," *Nucl. Sci. and Eng.* **71**, page 18 (1979).
9. J. K. BAIR and F. X. HAAS, "Total Neutron Yield from the Reaction $^{13}\text{C}(\alpha,n)^{16}\text{O}$ and $^{17,18}\text{O}(\alpha,n)^{20,21}\text{Ne}$," *Phys. Rev. C* **7**, page 1356 (1973).
10. D. L. LESSOR and R. E. SCHENTER, "Neutron Spectra from (α,n) Reactions in Plutonium Compounds Calculated from Hauser-Feshbach Reaction Theory," Brookhaven National Laboratory report BNWL-B-109 (1971).
11. M. BALAKRISHNAN, S. KAILAS, and M. K. MEHTA, "A Study of the Reaction $^{19}\text{F}(\alpha,n)^{22}\text{Ne}$ in the Bombarding Energy Range 2.6 to 5.1 MeV," *Pramana* **10**, page 329 (1978).
12. S. E. WOOSLEY, W. A. FOWLER, J. A. HOLMES, and B. A. ZIMMERMAN, OAP-422 (1975).
13. J. F. ZIEGLER, "Helium Stopping Powers and Ranges in All Elemental Matter," Vol. 4 of The Stopping Power and Ranges of Ions in Matter Series, Pergammon Press, New York (1977).
14. L. STEWART, "Determination of the Neutron Spectrum and Absolute Yield of a Plutonium-Beryllium Source," Master's Thesis, University of Texas (1953).
15. R. L. SEALE and R. E. ANDERSEN, "Intrinsic Neutron Source Strengths in Uranium Solutions," *Trans. Am. Nucl. Soc.* **63**, page 226 (1991).
16. L. SPECK and H. RICHARDS, "Energy Spectrum of Po-Be Neutrons," Los Alamos Scientific Laboratory report LA-111 (1944).

17. T. H. PERLMAN, H. T. RICHARDS, and J. H. WILLIAMS, "The Energies of the Neutrons from Polonium Alphas on Boron," Los Alamos Scientific Laboratory report LA-66 (1944).

18. G. J. H. JACOBS and H. LISKIEN, "Energy Spectra of Neutrons Produced by α -Particles in Thick Targets of Light Elements," *Ann. Nucl. Energy* **10**, page 541 (1983).